

BROADCAST NEWS

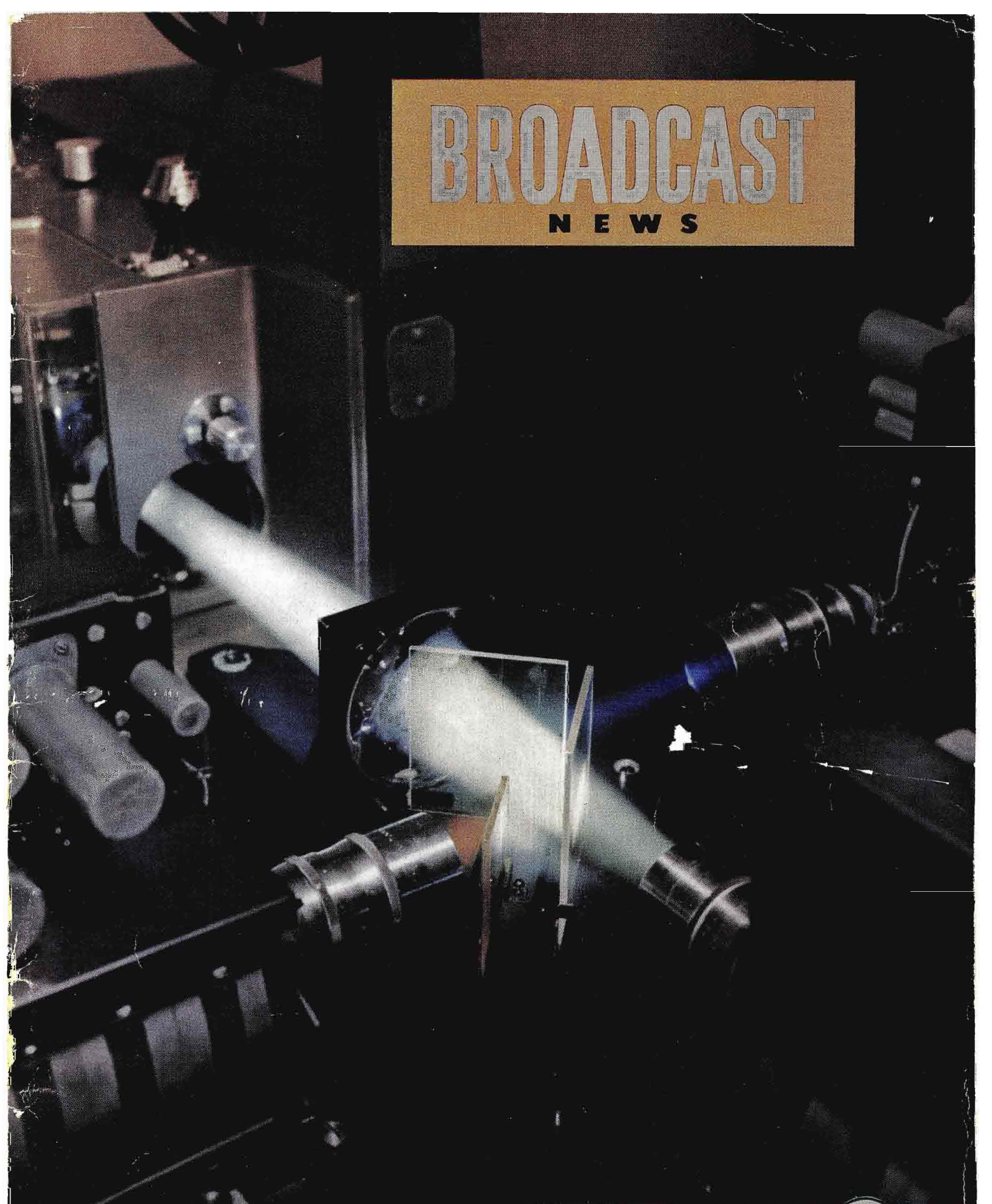

RCA "3-V" Color Film System . . . See Page 8

Vol. No. 79

May-June, 1954



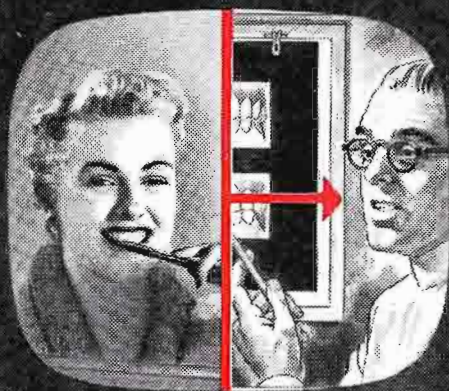

• Horizontal wipe

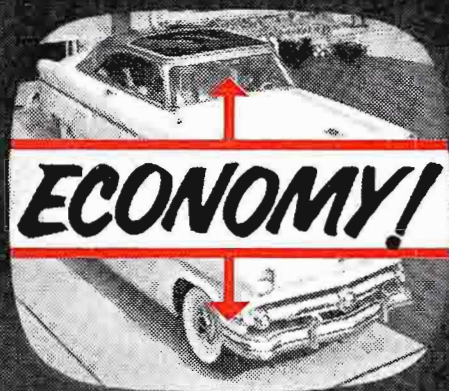

• Vertical split

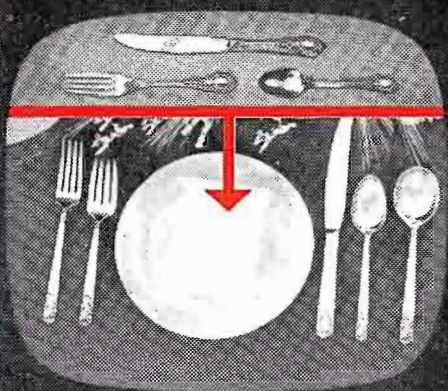

• Vertical wipe

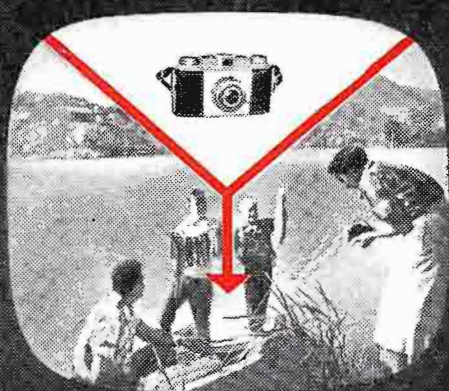

• Vertical wedge wipe



• Diagonal wipe



• Horizontal split



• Diamond insert and wipe



• Controllable corner insert

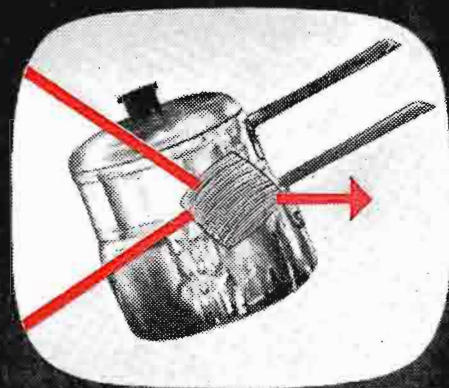

• Horizontal wedge wipe

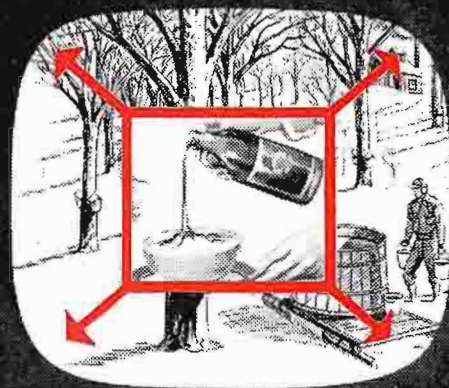

• Rectangular insert and wipe



• Controllable corner insert



• Optional special effect

12 ways to present your "commercial"

Now—with RCA's new Special Effects Equipment—you can have these 12 attention-getting effects right at your fingertips. You push the button for the effect you want. You swing the "control stick" (rotatable 360°) and put the selected effect in the picture wherever you want it. It's simple, inexpensive—requires no complicated equipment or extra cameras.

RCA's Special Effects Equipment consists of just two separate units; (1) a TG-15A control panel (shown below) and generator, (2) and a TA-15A amplifier. The Special Effects Panel can be inserted in any RCA Console housing. The other units can be mounted in your video racks. Installation couldn't be easier.

For quick delivery, order your RCA Special Effects Equipment direct from your RCA Broadcast Sales Representative.

← RCA Special Effects Control Panel—with 12 push-button selection and 360° rotatable stick control.



RADIO CORPORATION of AMERICA
ENGINEERING PRODUCTS DEPARTMENT
CAMDEN, N.J.

Number 79

May-June 1954

BROADCAST NEWS

published by

RADIO CORPORATION OF AMERICA
ENGINEERING PRODUCTS DIVISION CAMDEN, NEW JERSEY

PRICE *In continental U.S.A. --- \$4.00 for 12 issues*
 In other countries - - - - - \$5.00 for 12 issues

C O N T E N T S

3-VIDICON COLOR FILM CAMERA	<i>by H. N. Kozanowski</i>	8
THE WJTV STORY	<i>by J. R. Whitworth</i>	16
NEW 12½-KW UHF FILTERPLEXER	<i>by R. L. Meisenheimer</i>	22
WSUN INTRODUCES TV TO FLORIDA WEST COAST	<i>by Louis J. Link</i>	30
RCA's VERSATILE NEW SWITCHER	<i>by C. R. Monro</i>	38
WHP-TV, HARRISBURG, PA.	<i>by Dick Redmond</i>	42
RCA HOLDS ANTENNA ERECTORS' FORUM		47
BROADCASTING AND RCA INSTITUTES	<i>by C. E. Tomson</i>	48

"RCA PIONEERED AND DEVELOPED COMPATIBLE COLOR TELEVISION"

Copyright 1954, Radio Corporation of America, Engineering Products Division, Camden, N.J.

PRINTED
IN
U. S. A.



How to "Saturate"

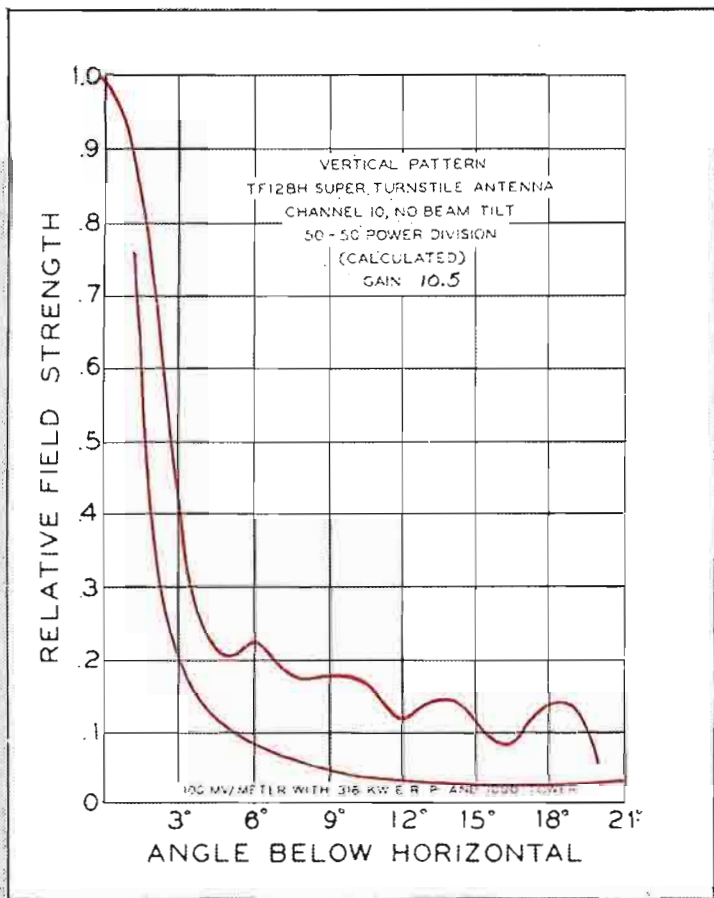
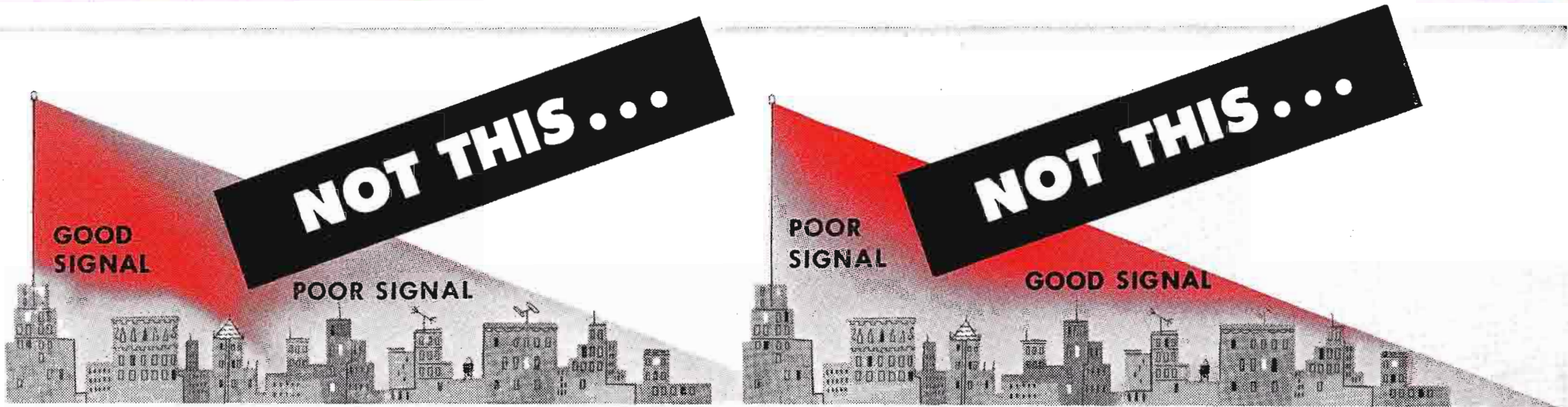

Vertical Field Pattern of new RCA TF-12BH 50-kw antenna. Note complete absence of vertical nulls. Operated in conjunction with an RCA 50-kw TT-50AH transmitter, this antenna will "saturate" your service area with strong signals.

RCA 50-kw VHF transmitter. TT-50AH Now in regular production, this transmitter is the ultimate in high power for channels 7 to 13. P.A.'s operate with standard power tetrodes (obtained from any RCA Tube Distributor).

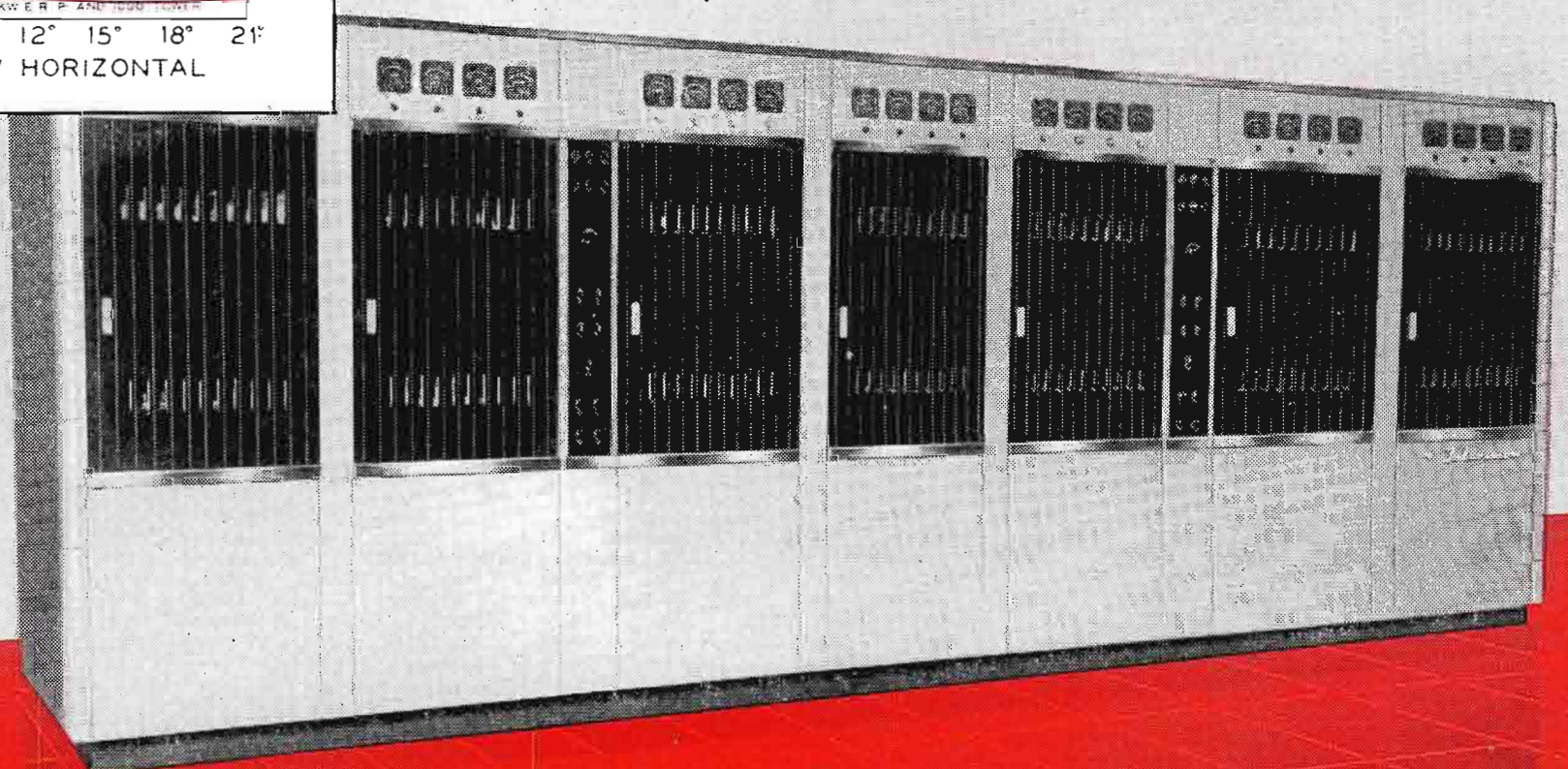

an entire service area

(CHANNELS 7 TO 13)



RCA's new 50-kw VHF transmitter, and an RCA TF-12BH Superturnstile antenna, will "flood" your service area with strong signals — close in AND far out!

Tailored to "consultants' specifications," RCA's 50-kw antenna-transmitter combination is your answer for maximum ERP *and* "saturation" coverage on channels 7 to 13.

"Rain" your signals in all directions!

No need to "beam" to reach specific areas. You get saturation everywhere—close in *and* far out. Reason: RCA's TF-12BH high-gain antenna delivers two to three times the required field strength—even in minimum signal areas. And it makes no difference whether you use an extremely high tower—or one of average height. This is the one transmitter-antenna combination that develops 316 KW ERP—*with power to spare!*

Antenna System takes full 50-kw Input!

RCA's TF-12BH high-gain antenna and antenna components will take the full output of the 50-kw VHF transmitter—with a high factor of safety. Designed for pedestal

or for tower-mounting, RCA antennas withstand windloads of 110 miles, and more. A unique switchable feed system enables you to switch power from one part of the antenna to another QUICKLY—an important advantage that will keep you on-air during an emergency.

A 50-kw VHF System—completely matched!

RCA can supply 50-kw systems matched precisely for peak performance—from antenna, transmitter, transmission line, fittings, tower, r-f loads, wattmeters, and diplexers—to the hundreds of individual components required by the carefully planned station plant.

Qualified planning help is vital!

For experienced assistance in planning a transmitter-antenna system that will literally "blanket" your service area with strong signals, call your RCA Broadcast Sales Representative. *He knows systems-planning from A to Z.*

RCA PIONEERED AND DEVELOPED COMPATIBLE COLOR TELEVISION



RADIO CORPORATION of AMERICA
ENGINEERING PRODUCTS DIVISION, CAMDEN, N. J.

THE ONLY

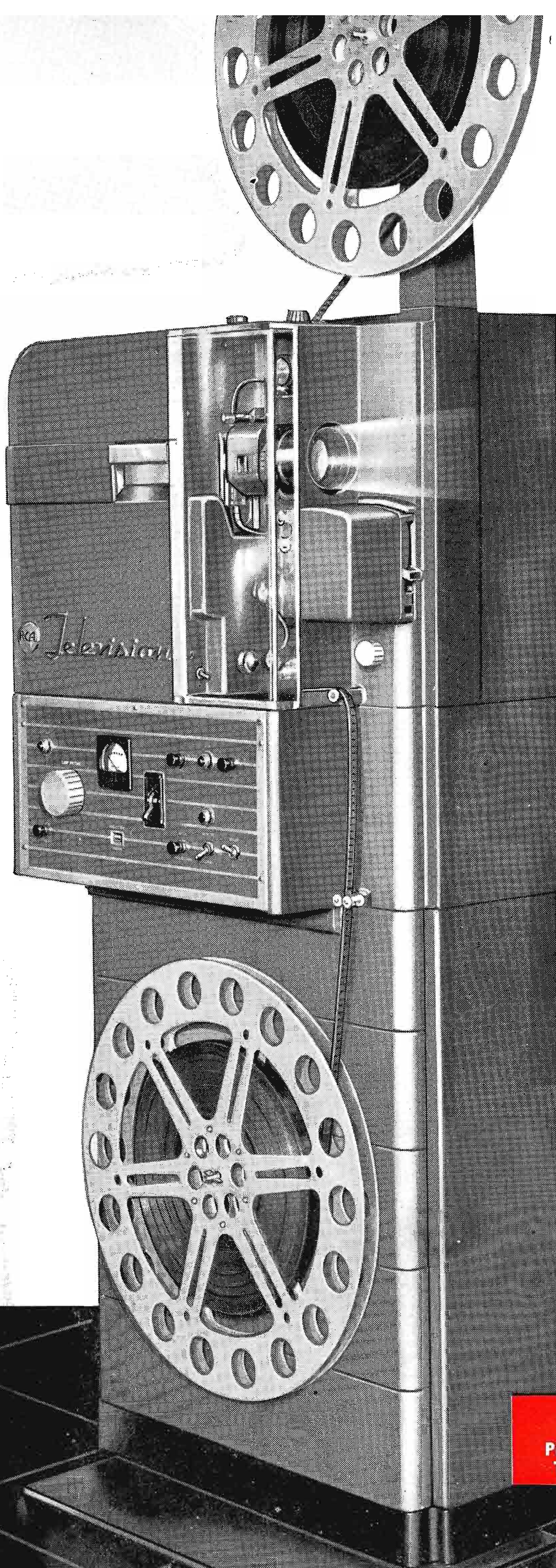

● 2-3 claw with jeweled tip assures long life

● Changes projection lamp *automatically*

● Dual focus controls

● New precision optical system—f 1.5 projection lens with "built-in" infra-red filter

● Handles 4000-ft. reels—compensated "take-up" provides constant tension

● "Still frame" projection with 2-second stabilization of picture and sound

● Framing without image displacement

● Framing and motor hand-turnover controls accessible from either side

● Instantaneous exciter lamp change . . . lever operated!

● Everything unit-built for easy maintenance

RCA
Type TP-6A
Professional 16mm
TV Film Projector

professional 16 mm film projector

...specifically designed for television!

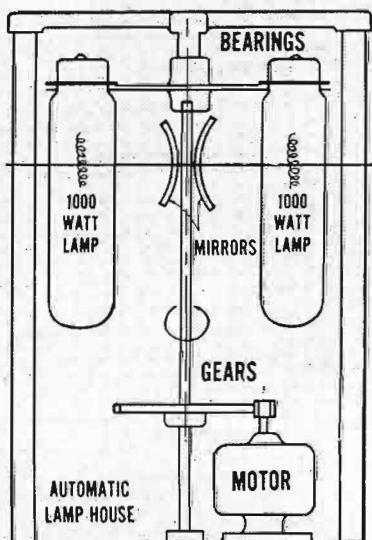

Automatic projection lamp change—takes less than a second!

HERE IS A professional equipment that fits television film standards exactly . . . the new RCA 16mm Film Projector Type TP-6A. It is designed to meet every requirement of the TV station looking for the best picture quality possible from 16mm film.

Unlike standard 16mm projectors now available, the TP-6A is newly engineered from "base-to-reels." New $f/1.5$ lens, new framing system, new dual focus arrangement, are among the features that contribute to its outstanding picture quality. New broadcast-

quality amplifier assures high-quality sound. New 4000-foot reels (with compensated take-up), new 2-3 claw intermittent in oil, and new automatic lamp change-over, combine to provide unsurpassed operating convenience and film-show reliability.

For a vast improvement in 16mm picture quality—nothing approaches the TP-6A. Check the 10 important features at the left.

For more details and delivery information call your RCA Broadcast Sales Representative.

An outstanding example of design simplicity

"See-through" Lucite door panel

Full inch clearance between aperture plate and lens gate

Simple film path

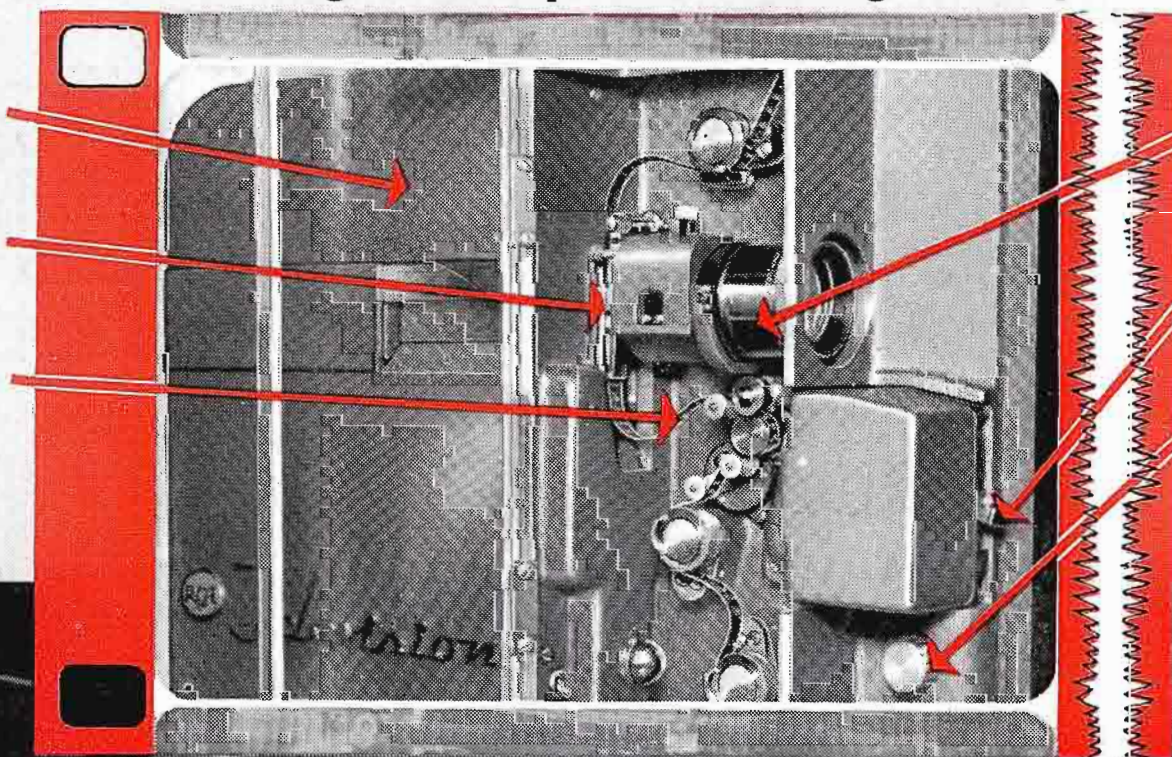

$f/1.5$ projection lens

Lever for exciter lamp change-over

Focus control—front and rear



RADIO CORPORATION of AMERICA
ENGINEERING PRODUCTS DEPARTMENT

CAMDEN, N.J.

NEW VIDICON

RCA's Superior



**For
MULTIPLEXING,
or direct use!**

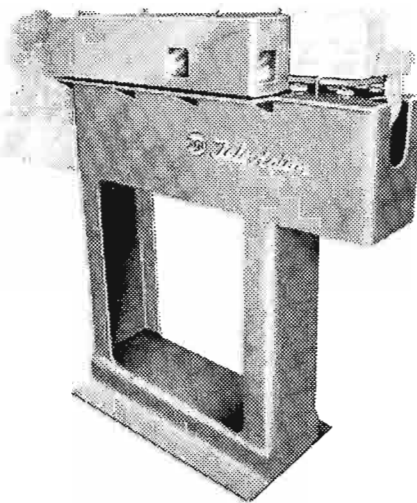

RCA's TK-21 Vidicon Film Camera can be used with RCA's Multiplexer, TP-11, for multiple picture inputs (see illustration opposite page). Or, it can be mounted directly on any of the RCA TV Projectors—such as the TP-16, TP-35, or TP-6A (see above).

film-camera

film camera chain

DEVELOPED HAND IN HAND with the new RCA-6326 VIDICON tube, RCA's TK-21 Film Camera does for *film* picture quality what the RCA Image Orthicon Camera has done for "live" picture quality.

"Live" picture sharpness!

For unsurpassed picture detail, choose the RCA Vidicon film camera! It's the only film pick-up system with enough signal output (and low enough noise in the signal) to use *aperture response correction*. Aperture response correction brings picture detail to maximum sharpness (detail resolution, 100% at 350 lines) while holding a high signal-to-noise ratio. *Benefit:* You produce finer film pictures . . . with a quality you get from your studio camera.

"Live" picture contrast!

The RCA Vidicon adds "studio" realism to your film pictures. The gamma characteristic of the Vidicon tube is ideal for film reproduction . . . 0.65, constant over a dynamic range of 150 to 1. *Benefit:* You get more realistic film pictures than ever before possible.

Low light source requirements!

The high light sensitivity of the RCA VIDICON film camera enables you to reduce projection lamp voltage, reduce heating, increase lamp life substantially.

Edge-lighting, shading eliminated!

The RCA VIDICON operates entirely without edge-lighting, electrical shading, and any other form of supplemental lighting. *Benefit:* You adjust "wall focus" and "beam" from day to day . . . then this camera virtually runs by itself.

RCA VIDICON Film-Camera Chain TK-21 includes:

- | | |
|------------------------------------|--|
| I VIDICON Camera MI-26021 | I TM-6B Master Monitor MI-26136-A |
| I RCA-6326 VIDICON Tube MI-26671 | I Master Monitor Kinescope MI-26655 |
| I Control Chassis MI-26061 | I Master Monitor C-R Tube MI-26665 |
| I Deflection Chassis MI-26081 | I Blower MI-26579-B |
| I Remote Control Panel MI-26241 | I Console Housing MI-26266-B |
| 2 WP-33B Power Supplies MI-26085-B | I Camera Cable & Connectors MI-26725-A10 |

For the finest TV film reproduction you've ever seen, specify an RCA VIDICON film-camera system. Ask your RCA Broadcast Sales Representative for technical details. In Canada, write RCA-Victor Ltd., Montreal.

RCA PIONEERED AND DEVELOPED COMPATIBLE COLOR TELEVISION



RADIO CORPORATION of AMERICA
ENGINEERING PRODUCTS DIVISION
CAMDEN, N.J.

4 picture sources in multiplexed use!

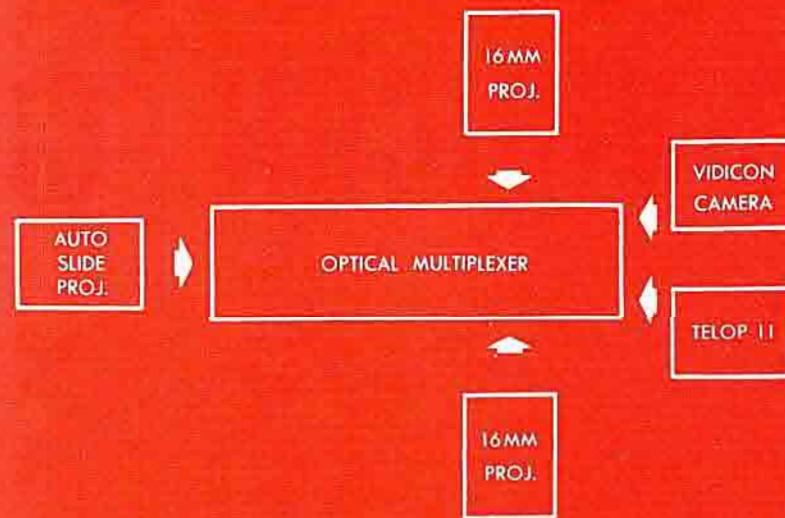
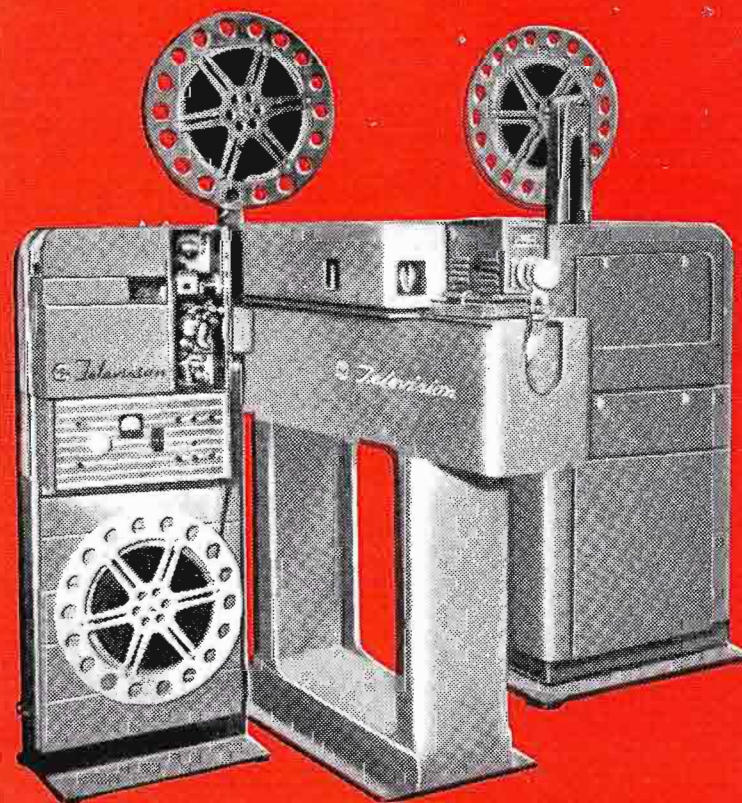

An RCA Multiplexer, Type TP-11 allows a single Vidicon Camera to accept up to four film picture sources—two 16mm or 35mm film projectors, a TP-3B, 35mm automatic slide projector, and a Telop II slide and opaque projector. The multiplexer is pictured above in a multi-input film system using two RCA TP-6A professional film projectors.

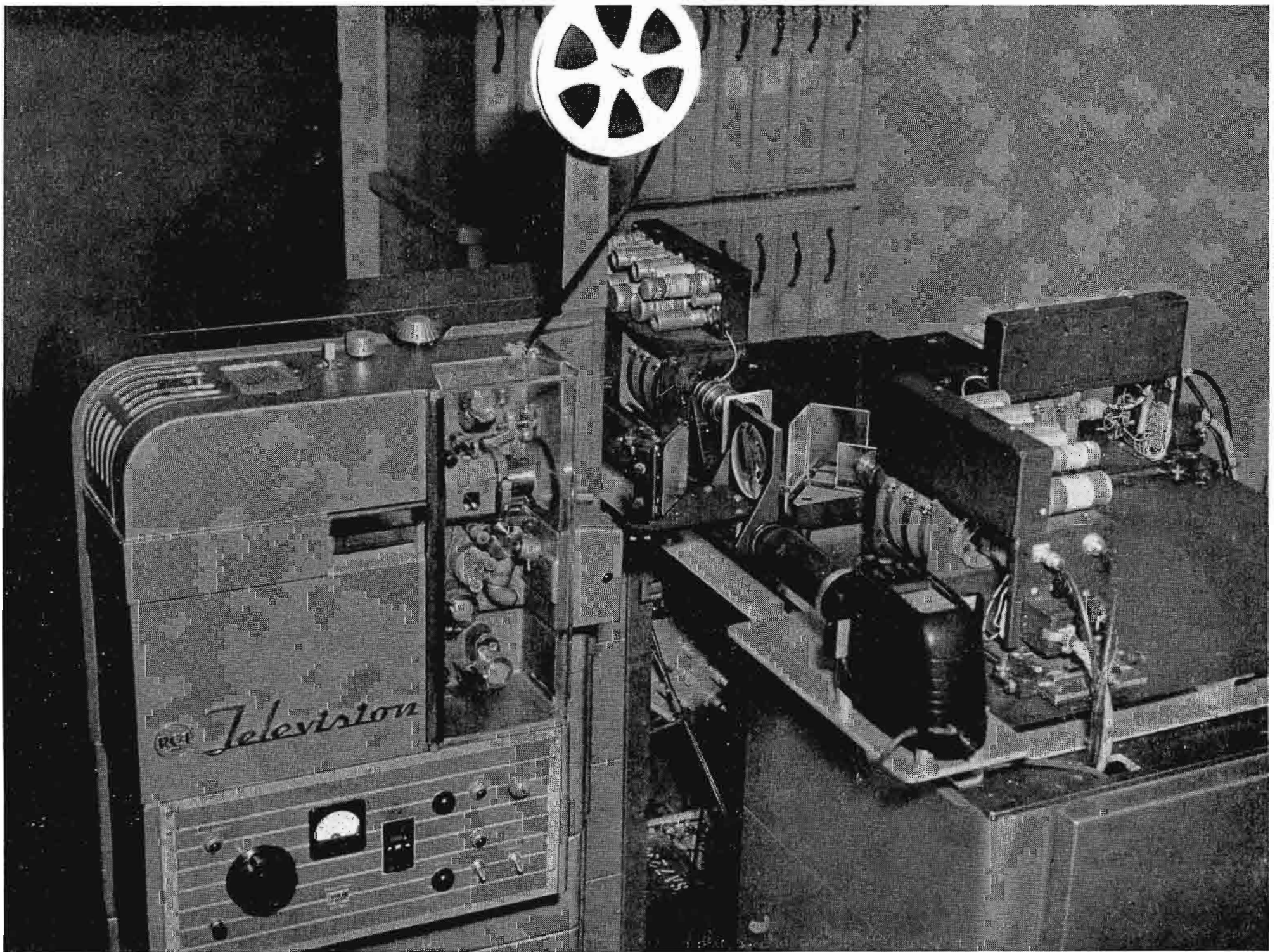

FIG. 1. Pre-production model of 3-Vidicon Color Camera with RCA TP-6A Professional Film Projector.

3-VIDICON COLOR FILM CAMERA

Television reproduction of color motion picture film has great practical and commercial implications in the compatible color TV program. In the development of this service, the ability to originate a color TV picture from motion film sources will be desired at practically the same time a station is equipped to rebroadcast color television signals from the network. At first it is likely that network color rebroadcasts and TV color film reproduction will furnish a substantial portion of color television program material for most of the television stations. Later phases of station development will provide live pickup or studio programming facilities in color. Thus the need for providing facilities for

By **H. N. KOZANOWSKI**
 Supervisor, Special Projects
 Broadcast Studio Section

color TV reproduction of color motion picture film assumes perhaps even greater importance than film reproduction in monochrome TV.

"Flying-Spot" Techniques

Until very recently, the only serious approach to solving the color film reproduction problem has been the use of "flying-spot" techniques. The fundamental characteristic of this system, which uses light from the scanned raster focussed on the

film to generate the video signal, is "non-storage". Signal is generated *only* when light from the flying spot falls on appropriate photocell amplifiers. This requires that either "fast pull-down" or continuous projectors be used for moving the film. Both types have been studied and tested at RCA. Field experiments have been conducted at NBC using the fast pull-down projector developed by W. R. Isom, of the RCA Engineering Department. This pulls down 16mm film within vertical blanking time. While performance under controlled conditions is excellent, the same technique appears impracticable with 35mm film, which requires that a continuous projector be used. Such projectors have received a

great deal of attention. Experience has shown that these projectors may be more expensive to build, and, in general, where high stability is required, may be more difficult to maintain at best performance levels.

All Methods Thoroughly Investigated

All methods which showed potential promise of obtaining high quality reproduction using as many available thoroughly tested techniques as possible were studied at RCA. We naturally were attracted to the possibility of using the vidicon camera technique developed successfully for monochrome film reproduction. Intensive development and study in the laboratory for the past two years and a limited amount of critical field tests have shown conclusively that the vidicon has very good resolution, well-behaved black level, very high signal-to-noise ratio, excellent gamma or gray-scale rendition, and can be operated satisfactorily with non-synchronous projectors by the use of straightforward long light-application techniques.

At the outset, it was apparent that the excellent features just mentioned for monochrome were equally important in color film reproduction, particularly as applied to non-synchronous operation and the use of the storage effect with "intermittent-type" film projectors, such as those used with the iconoscope for the past 18 years.

3-Vidicon Approach

The 3-vidicon approach requires the use of three vidicon tubes, one for each of the primary colors of the color film being trans-

mitted. These vidicons "look" at a real image produced by the projector at a field lens. By the use of a separate lens on each camera and appropriate choice of dichroics and color shaping filters, each camera sees only the red, the green, or the blue components of the color picture.

This approach is practically the same as that used with the RCA 3-image orthicon simultaneous camera for direct studio pick-up. Successful operation demands a high degree of accuracy in the electrical and optical registry of the three vidicon cameras, and uniformity in signal response over the raster surfaces.

It was important at an early stage of this development to evaluate the potentialities of 3-vidicon critically without having to wait for the completion of time-consuming detailed models.

Our experience with similar equipment gave us confidence in assuming that if the fundamental sensitivity, gray scale, black level, and non-synchronous operating characteristics could once be demonstrated as convincingly for color film as had been done for monochrome, the secondary problems could be handled by straightforward means with assurance of success.

3-V Breadboard

A breadboard setup using 3 independent monochrome vidicon chains was arranged. While the system was rather clumsy to adjust and keep in adjustment, it was possible to determine and demonstrate that sensitivity, resolution, black level control,

and non-synchronous operation are entirely adequate for color film reproduction. In fact, it was possible to obtain accurate registry over large enough raster areas to raise enthusiasm among critical viewers about the long-range potentialities of this method.

At this stage, we felt that in principle the complication introduced by the necessity for registration of optical and electrical images were completely outweighed by the simplifications possible in the use of 2 x 2 slides, standard long-application 16 and 35mm intermittent type projectors, and in the non-synchronous operating technique.

Advanced Development Model

The second phase of development, which was pursued vigorously, therefore concerned itself mainly with the design, building, and testing of highly accurate and precisely duplicable focus and deflection coil structures for the three individual vidicons of the 3-vidicon system. In addition an advanced development model of the complete system was designed and constructed. This model allows accurate positioning, focussing, and leveling of the optical system and cameras on a cabinet rack assembly which contains the required electrical circuits. In addition, either a 16 or 35mm long-application projector can be located in correct position with respect to the 3-vidicon camera. Such an arrangement, using the TP-6A 16mm film projector and a 2 x 2 inch slide projector is shown in the photograph of Fig. 1. A diagram of this system is shown in Fig. 2.

FIG. 2. Diagram of a 3-Vidicon Color Film System using TP-6A Professional Projector. Note how dichroic mirrors direct the blue, green and red images to their respective vidicon chassis.

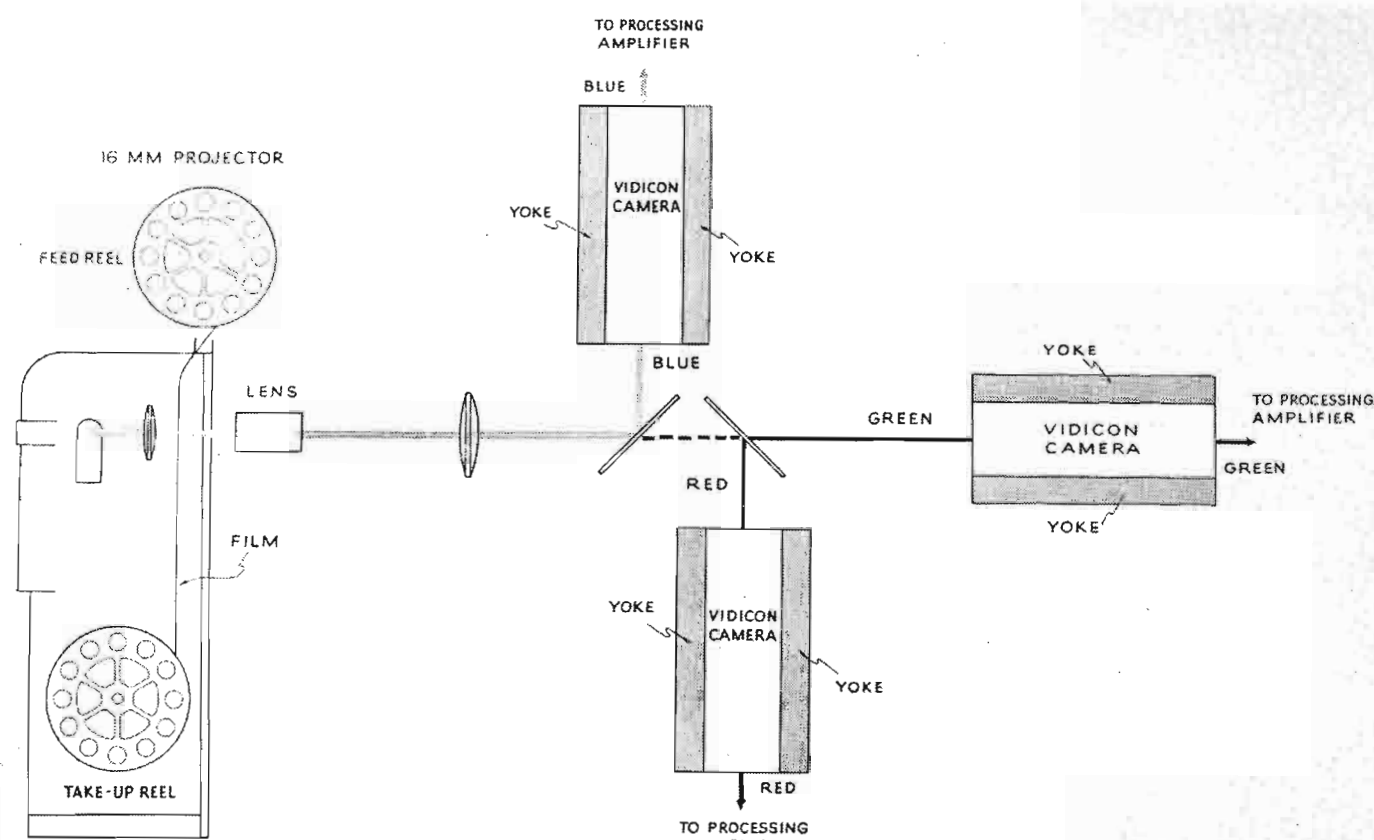



FIG. 3. Close-up view showing blue, green and red vidicon chassis and dichroic mirror system.

It should be emphasized that this equipment was designed purely as an advanced development and field test model. No attempt was made to provide optical multiplexing of several picture sources or to package the various components into a "final" configuration. The main criterion for this design in this model was that no

condition was to be knowingly introduced which might make a final picture of less than the best attainable or ideal quality. Data and tests on this model have furnished valuable information for multiplexing and camera arrangements of the product design model.

A close-up view of the field lens, and dichroic mirror arrangement, is shown in Fig. 3. The general features provided for focus, centering, and alignment of each camera are shown in Fig. 4.

Once it was established that high signal-to-noise, high quality color pictures could be readily achieved using non-synchronous operation of standard intermittent projectors, the vidicon deflection and registry problem was tackled and solved. The yokes and focus fields finally developed for the vidicon are shown in the details of Figs. 5 and 6.

FIG. 4. Single vidicon chassis showing focus, centering and alignment mechanisms.

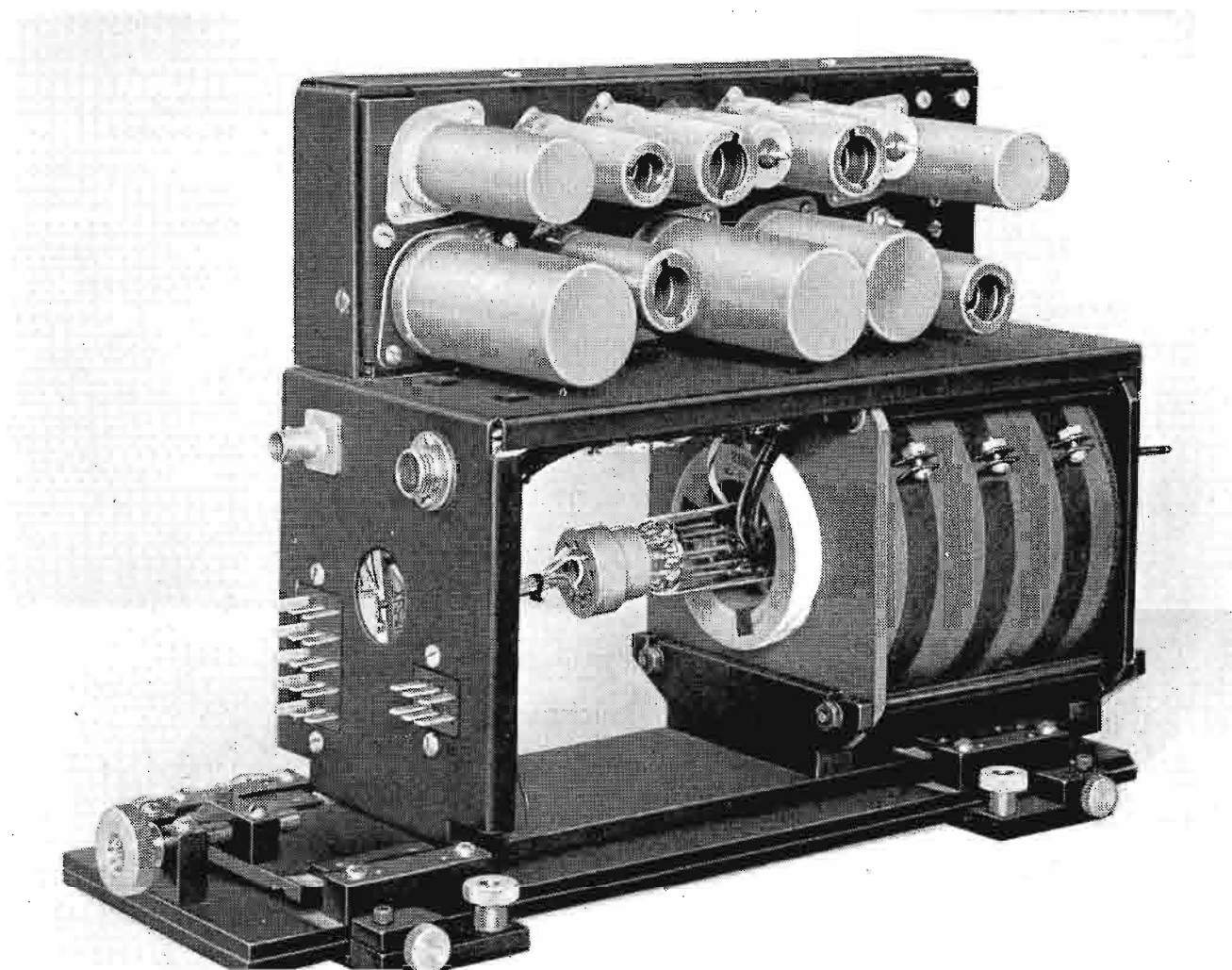

Focus and Deflection Assemblies

Sufficient background for this development was available from our work with the 3-image orthicon studio color camera. The goal was to develop methods of producing precision focus and deflection assemblies so that no selection would be required. The vidicon focus field assemblies are machine-wound, ferrite shielded, and accurately identical to within 1/10% for magnetic focus field. In the deflection assembly, the horizontal coils are precision-wound on curved mandrels, using indexed center inserts and phenolic strip spacers between

coil nests. By the use of thermoplastic-coated wire, the coils are fused after winding and retain their shape very accurately.

Vertical coils are wound in the flat, using indexed center inserts and coil spacers, and are then bent into the required form by suitable techniques which assure squareness of ends and accurate sides. Two vertical coils and two horizontal coils are then assembled on their respective insulating tubes by means of indexed center inserts. Suitable electrostatic shields are provided to suppress the horizontal deflection voltages at the vidicon signal electrode.

The vertical coil assemblies can be rotated with respect to the horizontal assemblies during test operation. In this manner they can be adjusted for zero skew or exactly perpendicular axes of deflection and then locked in position. This mechanical adjustment for skew correction is much simpler than the corresponding electrical methods for obtaining the same results.

The deflection coil assembly as a unit can then be accurately rotated with respect to the projected image by means of the sector gear arrangement shown in Fig. 7.

In this developmental model, the horizontal deflection coils for all three cameras are fed in parallel from a single high performance stabilized horizontal output stage. Separate horizontal centering controls are provided. For simplicity's sake, no differential horizontal size controls are provided. Small variations in horizontal deflection between cameras are compensated by appropriate changes in optical image size. Since differential vertical size and centering controls are provided for all three cameras, all of the facilities exist for registering three pictures.

Stability of Registration

A suitable transparency pattern, such as shown in Fig. 8, placed at the field lens plane provides a convenient chart for optical and electrical registry. It is rather interesting to philosophize on the registry procedure. If the yokes are held to precision tolerance, and the focus fields are all identical and carry the same current, and the operating temperature conditions for all yokes are identical, there is no reason to believe that the deflections on the vidicons should drift with respect to each other. Experience and careful observation have indicated that this is really the case, and that the small amount of drift in registry is directly attributable to drift or instability in electrical centering. In our case, it is possible to shift the vidicon cameras with respect to the lens image mechan-

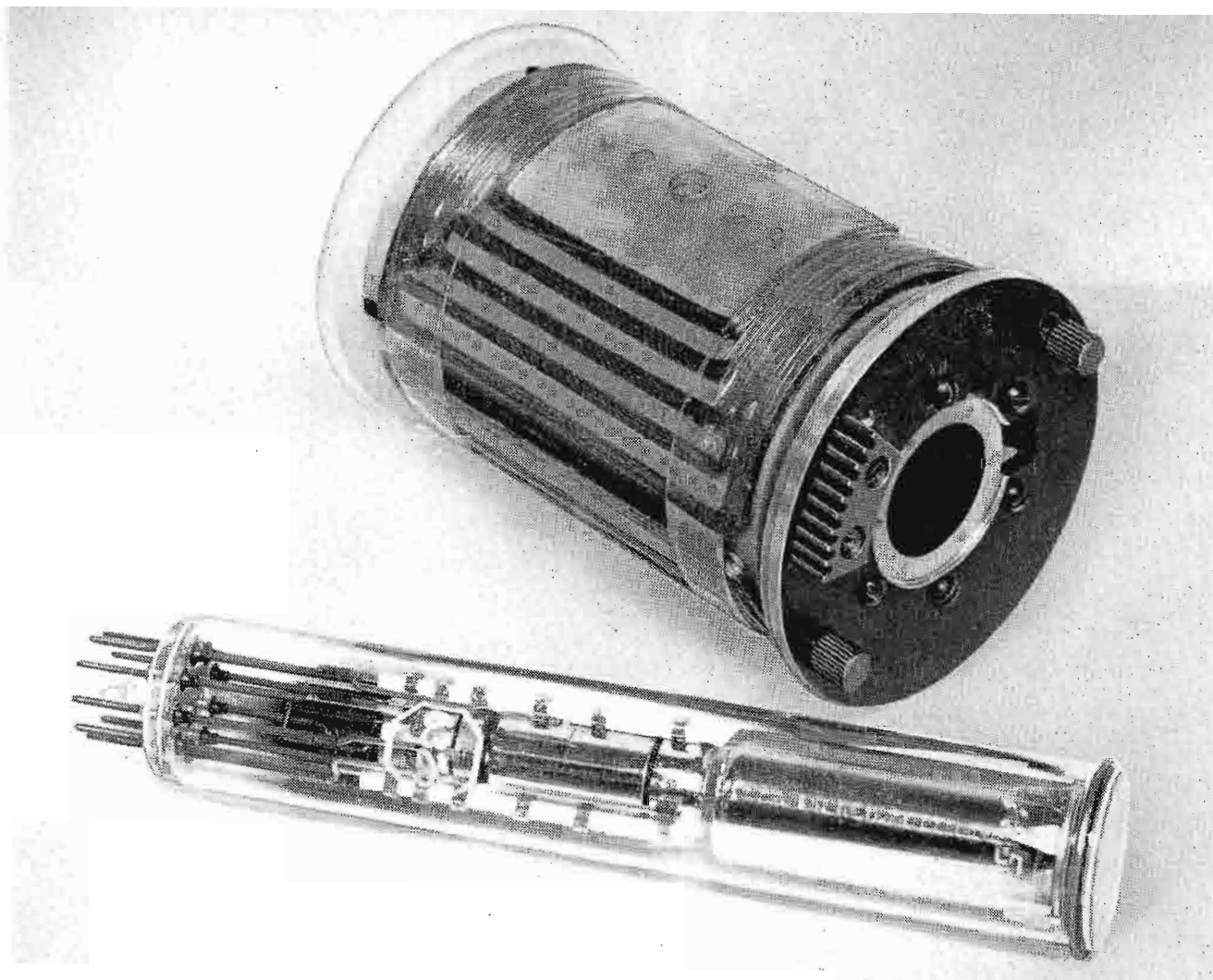

FIG. 5. Inner yoke and focus field for vidicon tube.

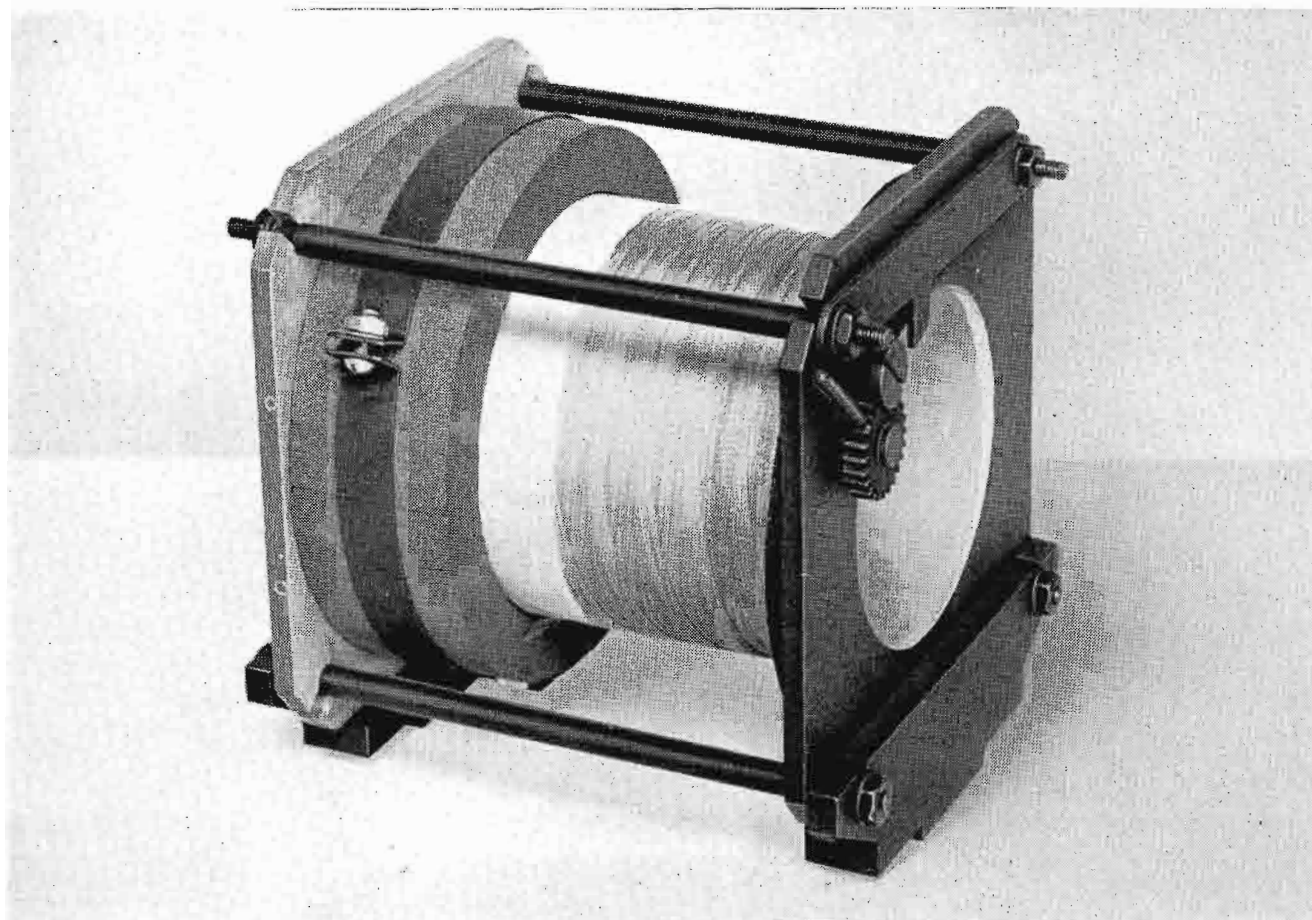
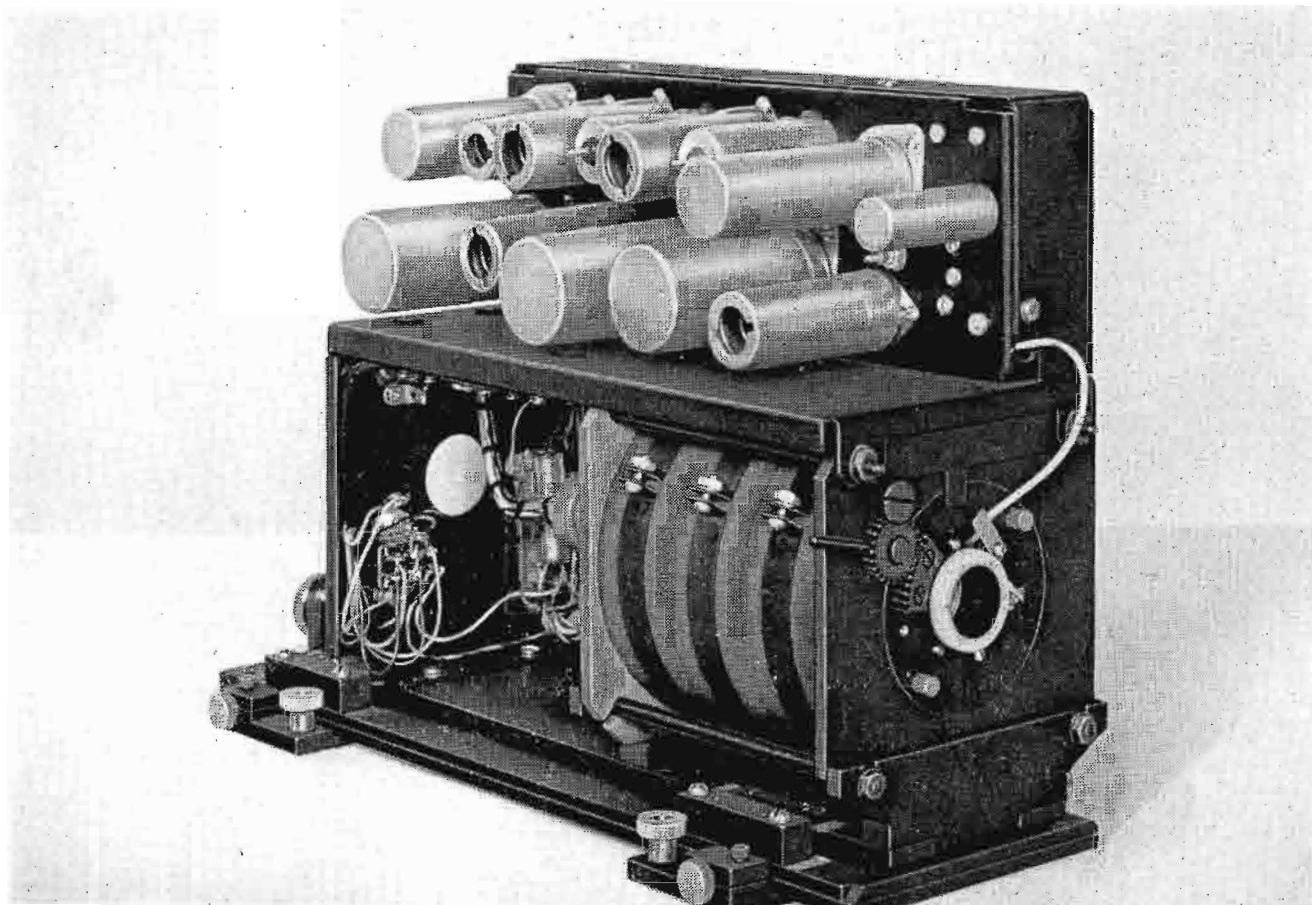

FIG. 6. Outer yoke and focus field for vidicon tube.

FIG. 7. Vidicon camera chassis showing the sector gear arrangement (right front) used for mechanical skew correction.



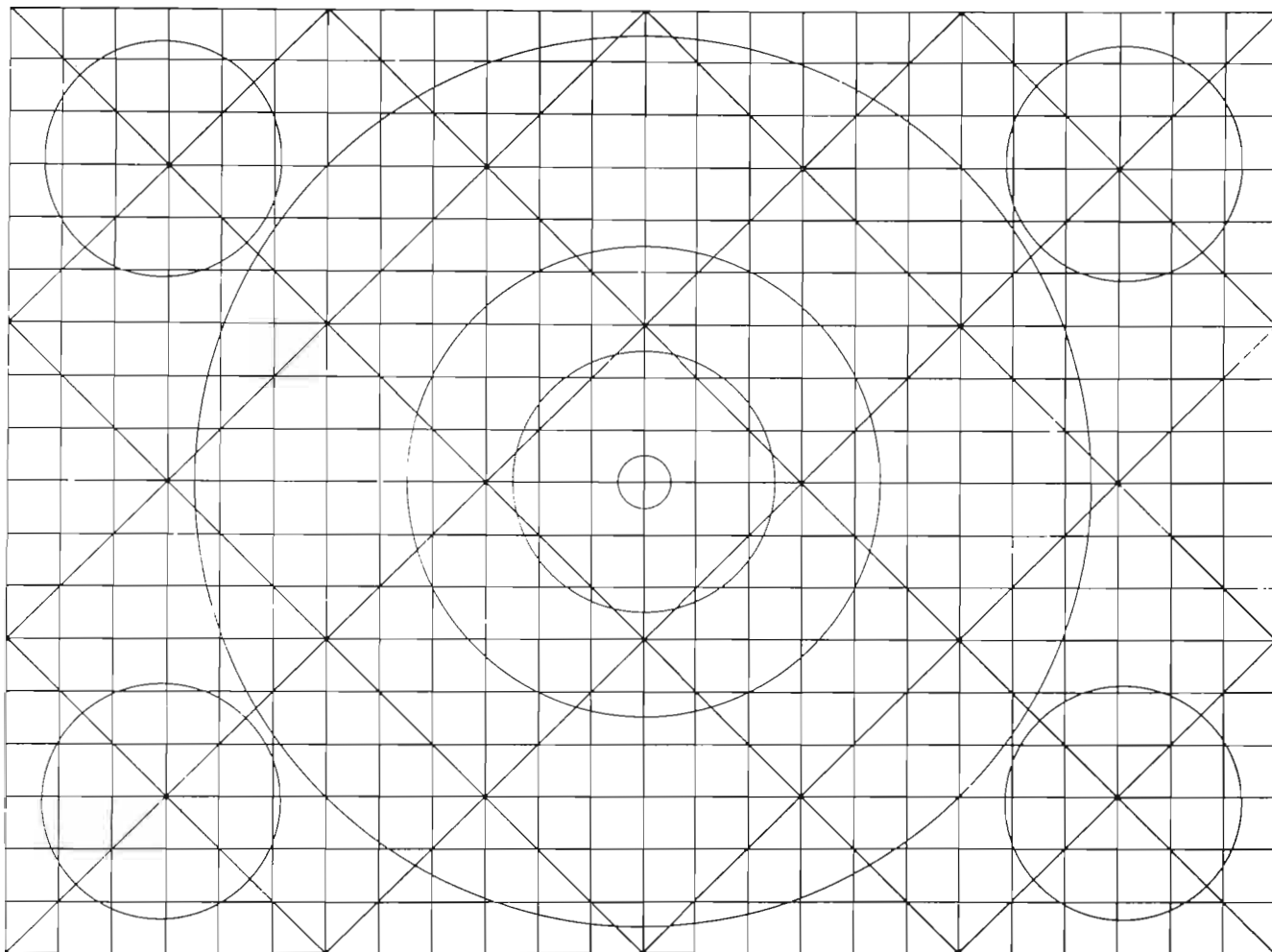

FIG. 8. Sketch of suitable transparency test pattern used for checking optical and electrical registry.

ically so that little or no electrical centering is required for registry. Under these conditions the pattern was first registered and the stability of registry was observed for several hours. The system was then shut down overnight, and turned on the next morning. It was found that after a 15 minute warm-up period, the registry, with no controls touched, was substantially as good as on the previous evening. This means that with proper design, the 3-vid-

icon system can be made to have inherently excellent registry and to maintain it for long periods of time. Once adjusted, the system should stay put.

A general view of the deflection assembly is shown in Fig. 9.

The auxiliary control unit is shown in Fig. 10.

The processing amplifier and the operating control panel are shown in Fig. 11.

3-V and Standard Television Projectors

It is perhaps worthwhile to discuss long-application intermittent-type projectors used with 3-V, describing the 3-2 type of film motion, showing how long application is achieved, and pointing out why it is necessary. The standard film projection rate is 24 frames per second. All U. S. television systems show 60 television fields or 30 frames per second. From the diagram of Fig. 12, it can be seen the time required to show two film frames ($2/24$ or $1/12$ second) is identical with the time to show five television fields each of $1/60$ second duration ($5/60$ or $1/12$ second). For further discussion, it is useful to introduce the standard concept that $1/24$ second, the basis of timing, is 360° of the cyclical sequence of film transport and exposure. Then, since two film frames are $2/24$ or $1/12$ second or 720° , and are identical with 5 television fields, each television field of $1/60$ second has a duration of 144° .

With this concept, it is easy to visualize, in terms of a television scanning field, what is meant by a pull-down interval of, say 50° . This is $50/144$ or approximately $1/3$ of a vertical field interval. This is the period during which film is in motion in the gate and during which the projector light must be turned off. The time that the film is actually exposed is the light application time. This can be controlled by the width of a rotating shutter slot, or by circuit constants in pulsed light techniques.

In practice, the light application pulse may vary from about 10° or 7% applica-

FIG. 9. Deflection Assembly.

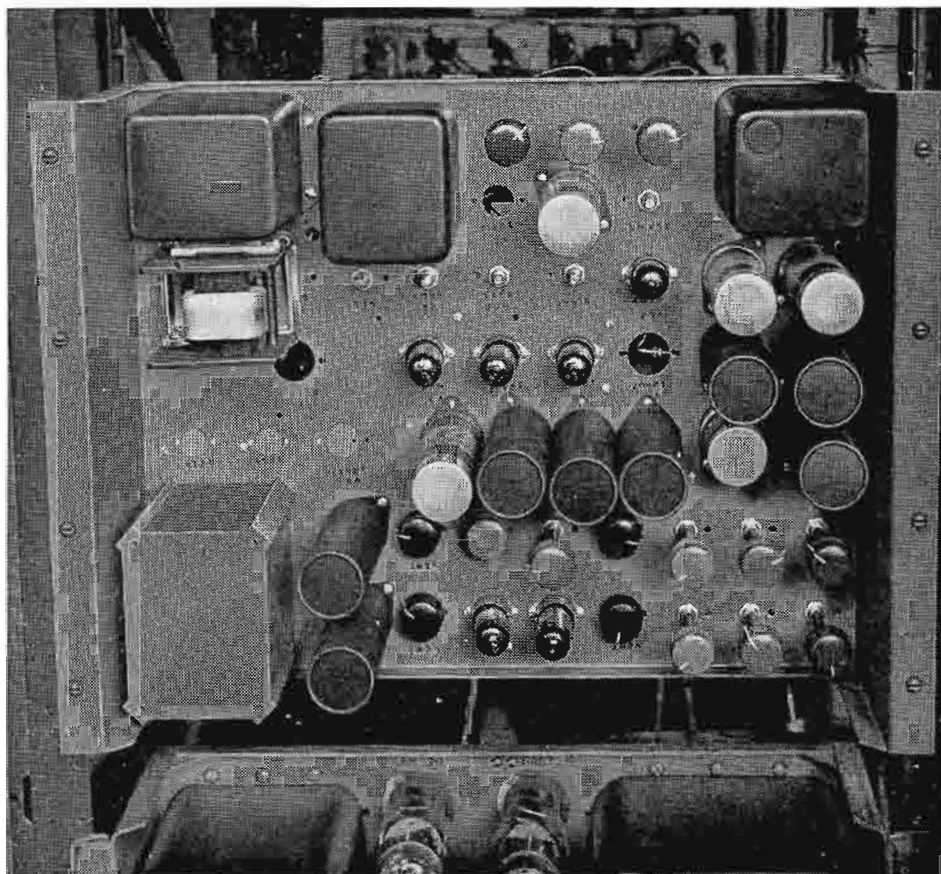
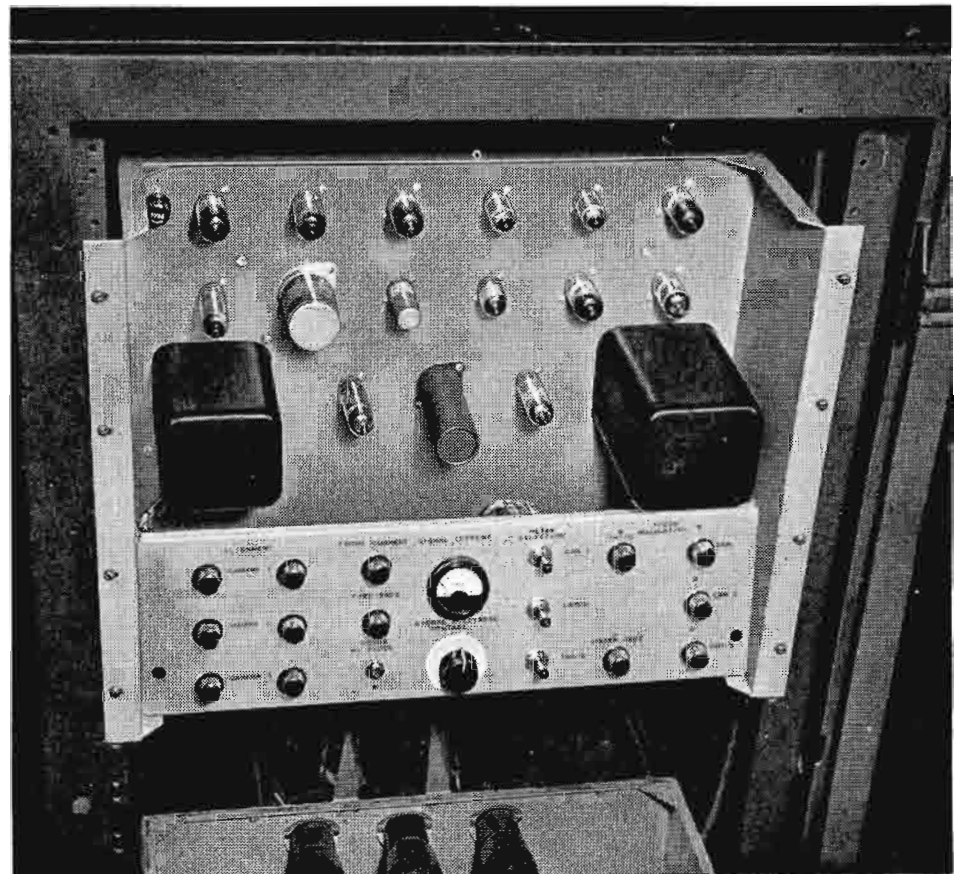

FIG. 10. Auxiliary Control Unit.



tion for the iconoscope exposed during vertical blanking, to a maximum of 94° or $94/144$ or 68% for the Vidicon. It is also evident that if each frame is to be exposed at exactly the same interval of scan, this can be done by arranging the intermittent pull-down mechanism so that the film is held in the gate for $2/60$ of a second or 2 fields, and then for $3/60$ of a second or 3 fields, and maintaining this 2-3 dwell ratio. Since two frames are shown in $5/60$ or $1/12$ second, the standard 24 frames-per-second film transport rate is still in effect. Now, a single slot shutter rotating at 3600 RPM can produce light application pulses as wide as 68% , at exactly the same interval of successive television field scans, and will cover film pull-down adequately.

Since a storage tube such as the Vidicon works on integrated light, this means that by widening out the application pulse from 7% to practically 70% , the integrated available light will increase by this factor of 10. On monochrome, this means that a projector lamp of $1/10$ of the light output working long application is just as effective as a 1 kw lamp working at short application. In the case of color, the use of separation filters and dichroics, plus higher film density, make it necessary to provide greatly increased light. This long-application method furnishes a very convenient way of providing the additional projector light and at the same time allows non-synchronous operation of the chain.

FIG. 11. The Processing Amplifier (bottom) and Operating Control Panel (center) are shown rack mounted beneath an RCA TM-6B Master Monitor. These units comprise the control function of the 3-Vidicon Color Camera Chain.

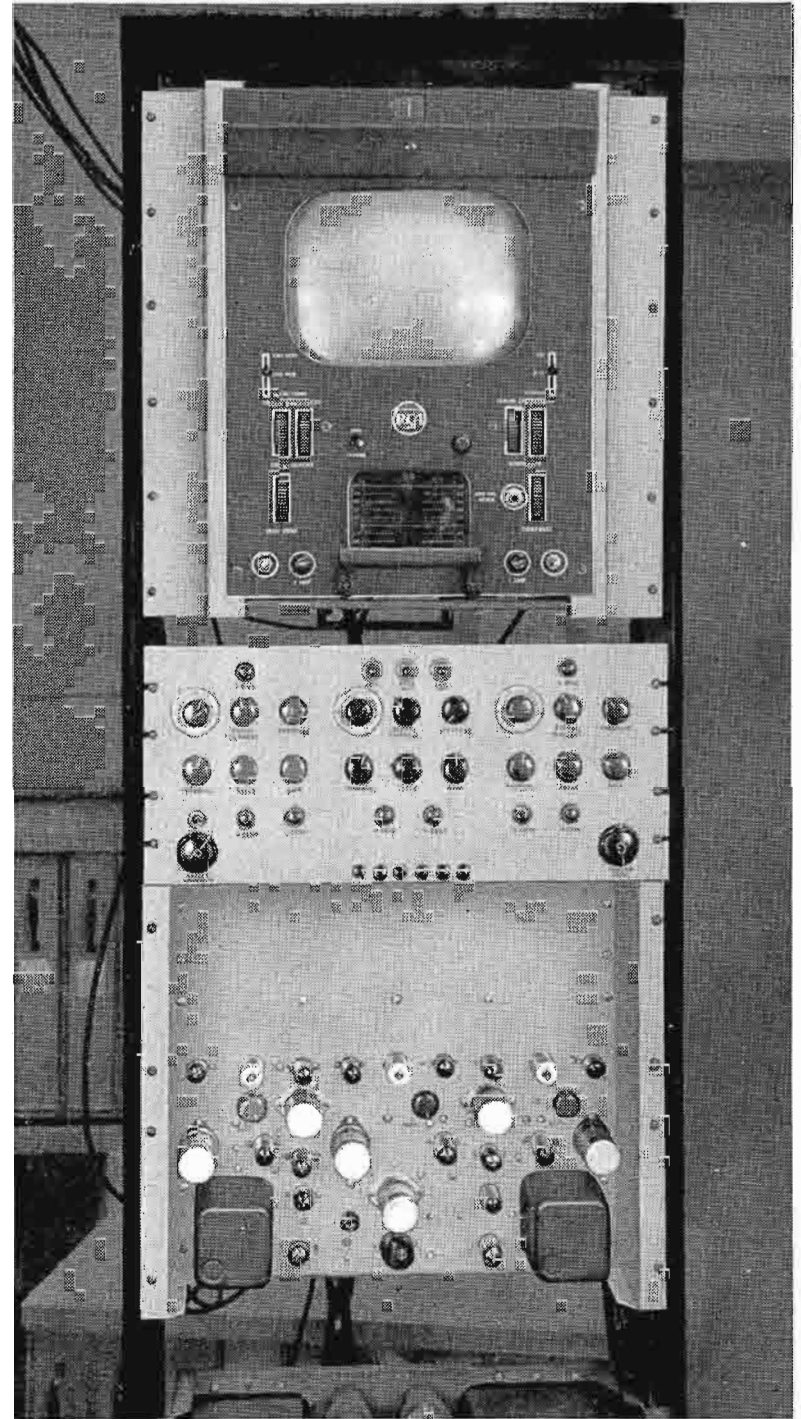
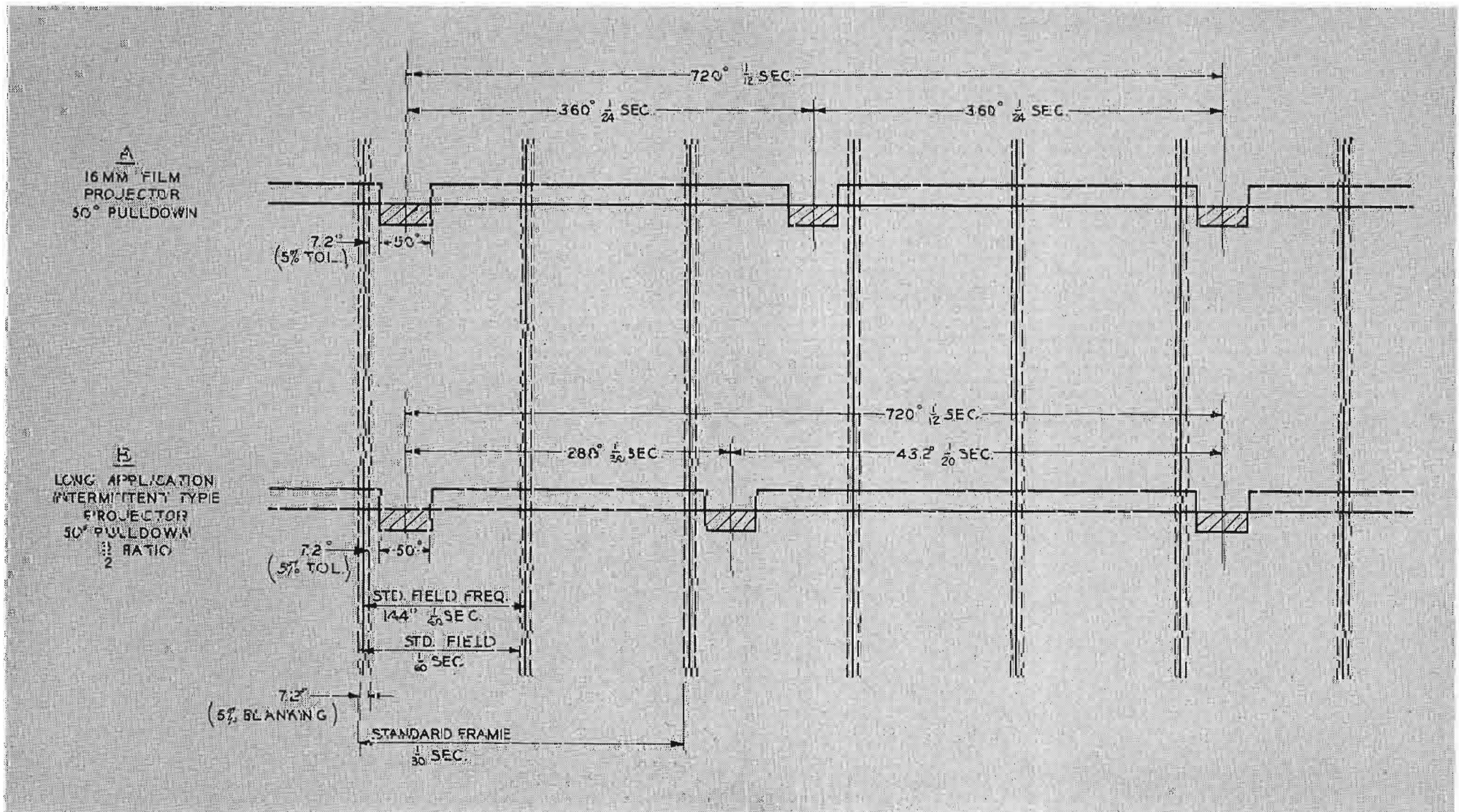

FIG. 12. Diagram showing projector time cycles of a conventional 16mm Film Projector, as compared to a long application intermittent type projector.



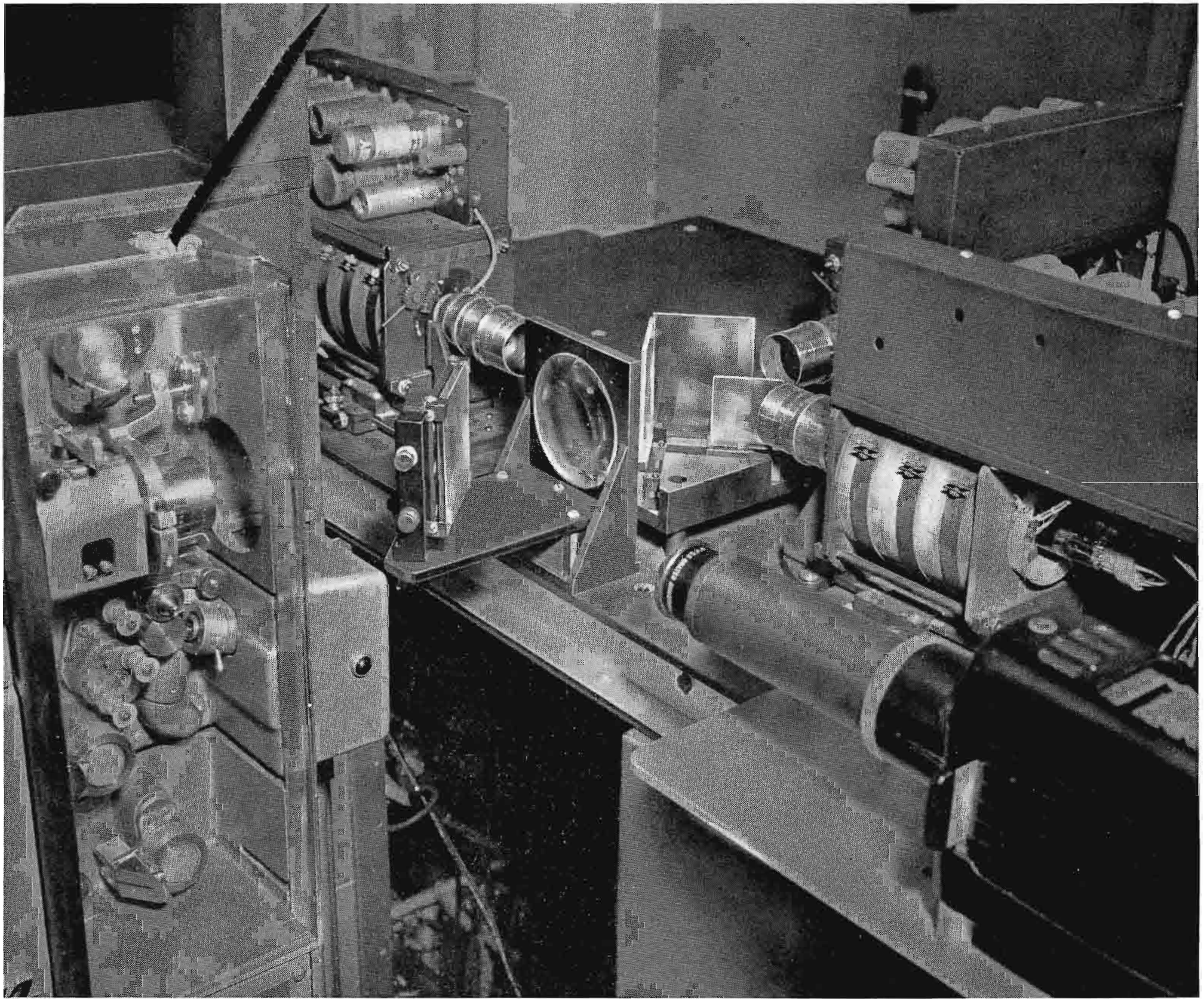

FIG. 13. Close-up view showing simple multiplexing arrangement of 35mm slide projector and 16mm film projector.

Multiplexing the 3-V

A close-up view of Fig. 13 shows one method of reproducing 2 x 2 inch transparencies as well as 16 or 35mm color film. Here, a conventional slide projector is used with a movable front surface mirror to project a real image in the field lens plane. Excellent reproduction of slides has been obtained. Obviously other methods of optical multiplexing are possible to provide inputs from 16 and 35mm film projectors and 2 x 2 slide projectors into a 3-vidicon chain for programming continuity.

A possible arrangement is shown in the diagram, Fig. 14. Basically, the arrangement of Fig. 14 provides sufficient optical length of path between projectors and the three Vidicons to allow for the use of mir-

rors. In this way, three projectors can be arranged for easy loading, access, and operation, and can be selected at will as sources of program material. The selection can be done by moving the multiplexing mirrors, or, if ample light is available, by using neutral density dichroic mirrors and turning on the required projector light source. In the case of 16mm film, the Vidicon image diagonal is practically the same as that of the film frame, and the magnification is only slightly greater than unity. However, the real image produced at the plane of the field lens has been magnified by five to ten times the original film size by the projector lens and then demagnified by each Vidicon lens by approximately the same factor. This gives the original unit magnification desired, but develops a work-

ing optical distance of 10 to 20 focal lengths, or 20 to 40 inches from projector to Vidicon face. It can be seen that the function of the field lens is to converge the diverging cone of light rays from the projector into the Vidicon lenses so as to obtain substantially uniform illumination and field flatness. The general packaging of the various components of the system is shown in the block diagram of Fig. 15.

3-V System Advantages

The advanced development equipment just described has been demonstrated to a large number of consultants, television engineers, and station owners and managers. It is gratifying to note that their enthusiasm for this method of color film

reproduction is very high. The results demonstrated that:

- (1) Non-synchronous operation of standard intermittent projectors for color is completely practical.
- (2) High signal-to-noise ratio pictures can be produced.
- (3) Resolution, and gamma without further correction, are excellent.
- (4) There is adequate light reserve for handling dense film.

- (5) There is no fundamental problem in obtaining and maintaining registry of the images.
- (6) Picture steadiness is excellent and typical of that obtained with intermittent projectors.
- (7) Color fidelity of the vidicon system can be made as good as that of the studio image orthicon camera.
- (8) The compatible monochrome picture has excellent signal-to-noise, gamma, and resolution. The importance of this

cannot be overstressed, particularly in the first few years of color when the majority of viewers will have only monochrome receivers.

Acknowledgments

Progress in this 3-V color film development has been due to the efforts of many engineers, particularly S. L. Bendell, E. M. Gore, and H. C. Shepard in advanced development, and D. J. Parker and L. T. Sachtleben of the optics group.

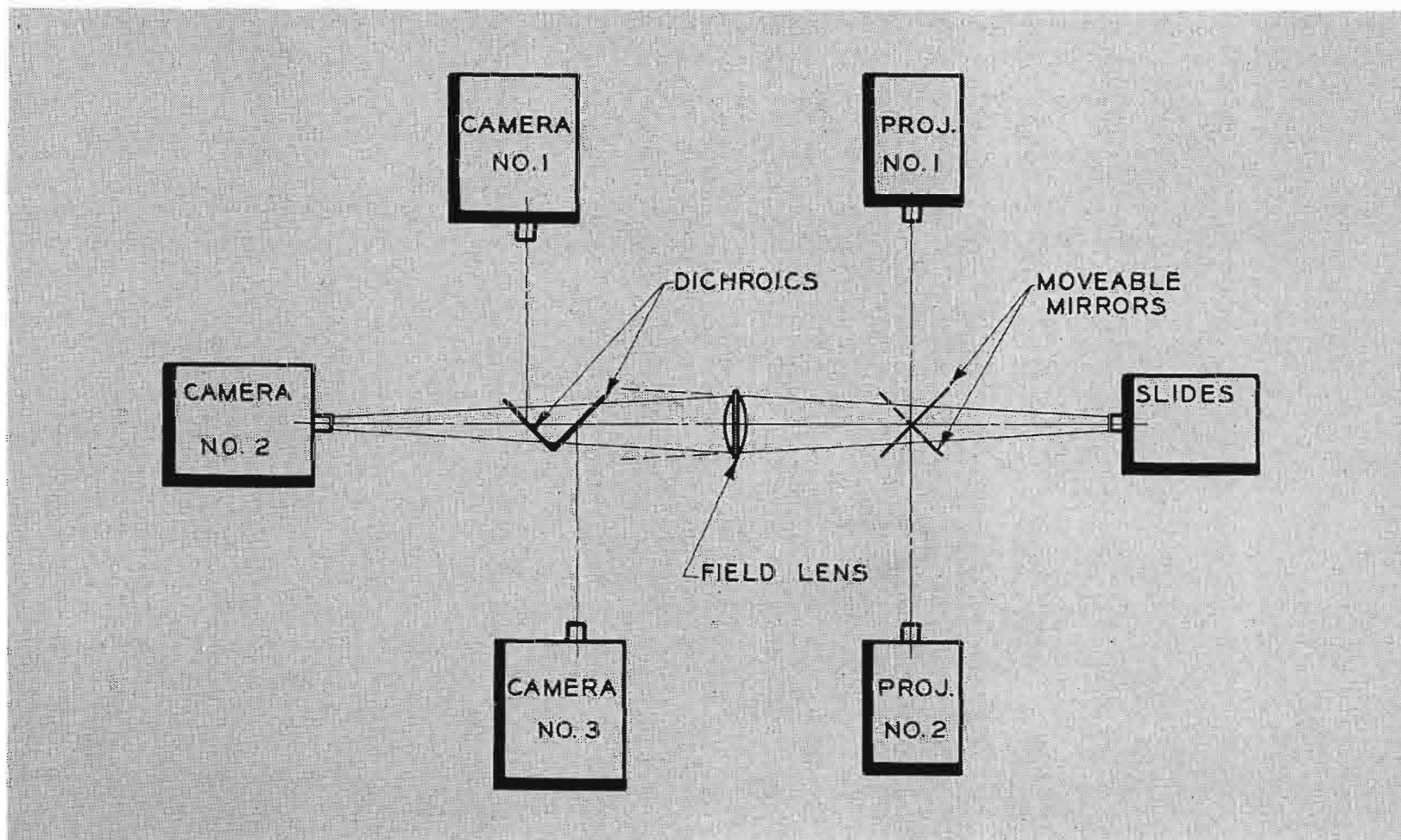

FIG. 14. Block diagram showing a possible multiplexer arrangement for the 3-Vidicon Camera used with two film projectors and a single slide projector.

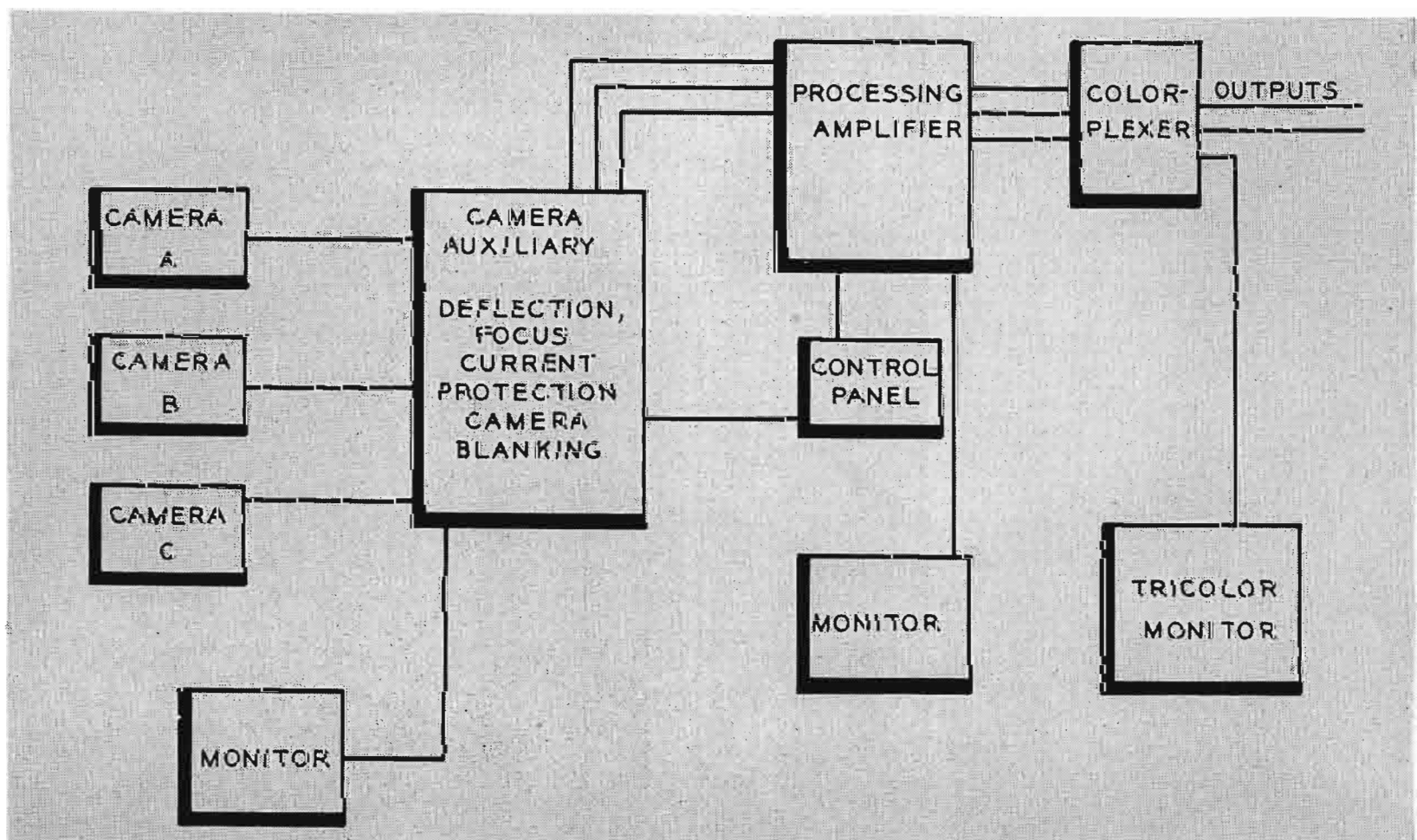

FIG. 15. Block diagram of the 3-Vidicon Color Film System showing general packaging of the various components in the system.

THE WJTV STORY

The third quarter of 1952 saw the issuance of a construction permit to the Mississippi Publishers Corp., publishers of the Jackson Clarion Ledger and the Jackson Daily News, for WJTV in Jackson, Mississippi; the choice of channel and physical

by **J. R. WHITWORTH**
Chief Engineer, WJTV

location being strongly influenced by Raymond M. Wilmotte, Consulting Engineer, and of course C.A.A.

This writer welcomed the opportunity to explore the advantages of UHF transmission and assumed the duties of Chief Engineer on September 29, 1952.

The ensuing few weeks tell a familiar story to those who have endured the endless distractions, the countless conferences,

and the trials of coordinating the activities of the architects, lighting engineers, heating and airconditioning engineers, electrical engineers, Bell Telephone and A.T.&T. engineers, tower engineers, attorneys electrical, plumbing, and heating contractors, tile-setters, painters, the time-consuming interviews with sales representatives, prospective employees, and just plain sensation seekers.

Earlier Studio/Transmitter Planning

The exact site for the location of the combined studio and transmitter operations of WJTV was chosen and the stakes were driven to begin construction in early October of 1952. As many men were put on the job as could be used without getting in each other's way.

The chief engineer was under instruction from the owners to achieve a permanent building suitable for an interim operation combining studio and transmitter functions, as plans then called for construction of downtown studios in a matter of a year or so. Considerations of ultimate economy and ultimate utilization of space under this premise prohibited extensive studio and personnel facilities since they would fall into disuse under a separate studio system. Accordingly, provisions were made for a tiny 20 x 30 studio, large control room, large space at back and sides of transmitter for future power increase, small announce booth, separate projection room, reasonable

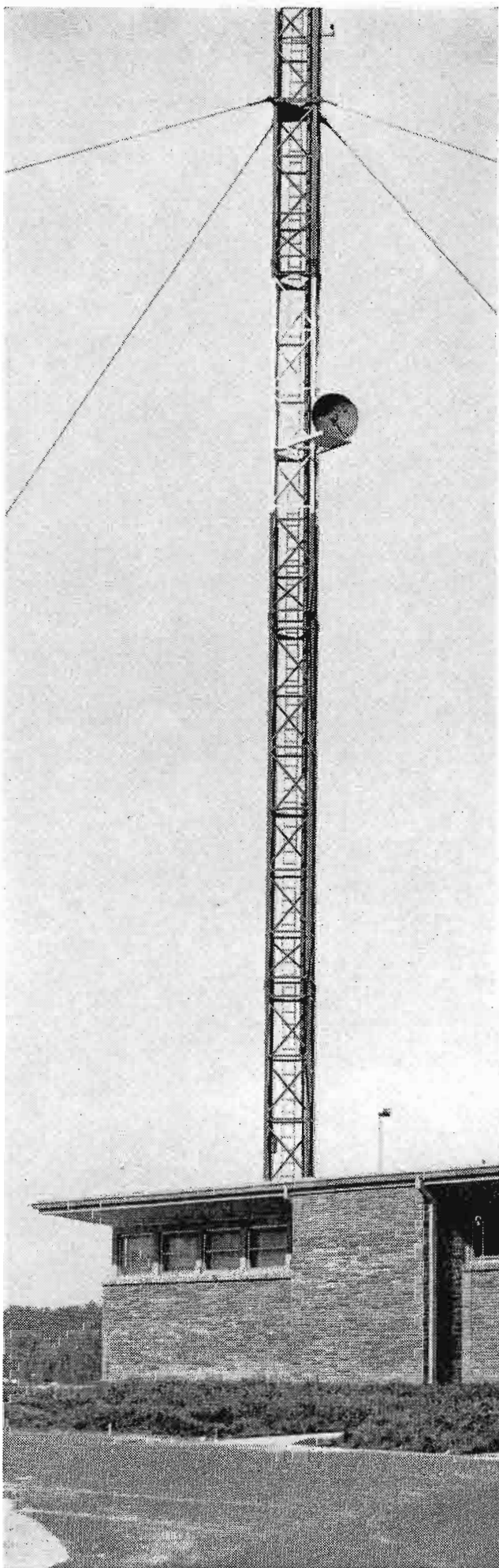

J. R. Whitworth, Chief Engineer, WJTV.

FIG. 1 (below). Exterior view of the WJTV Brick Transmitter Building and Tower.

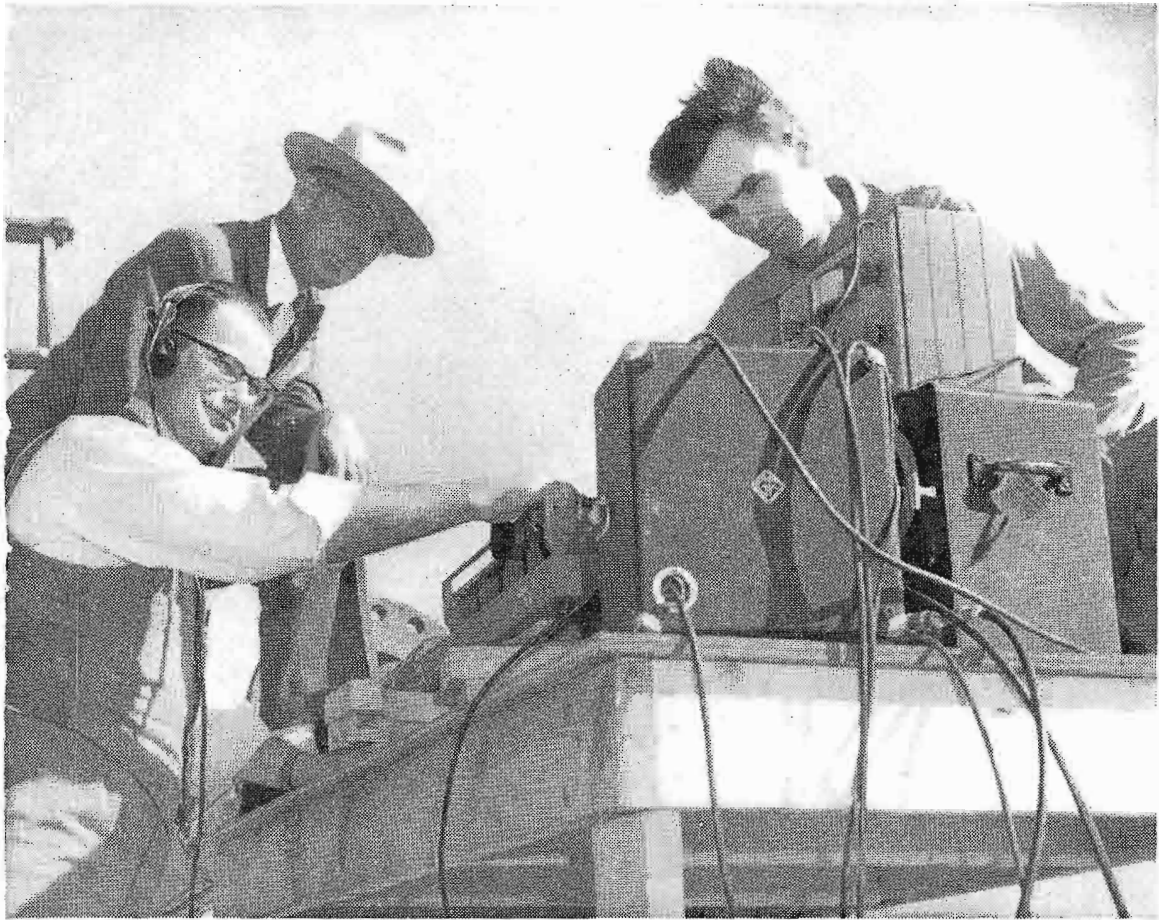

FIG. 2. (Left to right): J. R. Whitworth, Chief Engineer WJTV, D. Johnson, RCA Service Co., and S. J. Parks, WJTV Engineer, shown conducting installation tests and measurements.

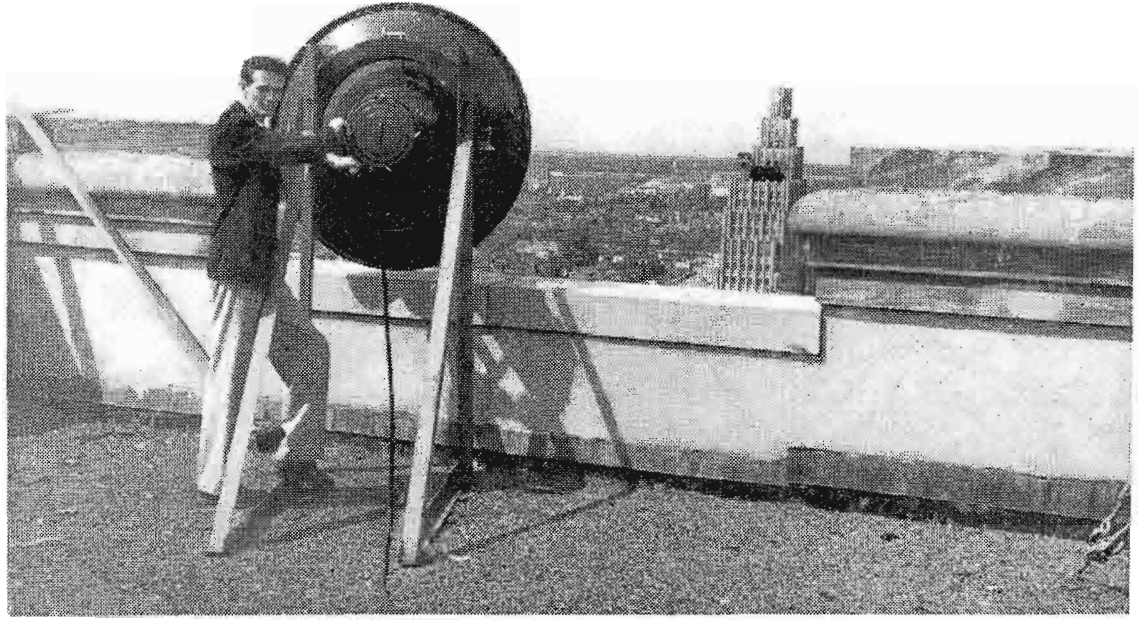

FIG. 3. View of the WJTV microwave transmitter dish which is beamed to WJTV tower and receiver at plant. A tower is midway between the dish and building.

shop, small reception room, chief engineer's office, and garage (or storage space).

Since interim operation was contemplated, it was not considered desirable to sign a long-term contract with the Bell people for a physical video loop to feed network from town out to the plant location. The use of microwave was suggested but at this juncture the telephone company was unable to furnish it in time for the station opening.

This difficulty was resolved by selecting a suitable downtown location for line of sight to the transmitter location and purchasing our own RCA microwave system.

We then had this site designated by the F.C.C., A.T.T., and CBS our basic network affiliation, as our downtown studio. The spot picked out was the Deposit Guaranty Bank building, about 220 feet high, at the corner of Lamar and Capital streets in the center of downtown Jackson. Directly across the street was the telephone company having underground cable and conduit facilities thereto.

Microwave STL System

This building is also the most desirable location in town for microwave pickup from a mobile unit and is regularly used for this purpose.

Space was acquired on the roof of this building and a penthouse erected of welded steel and Cemesto-board construction which

is storm and fire proof. An angle iron frame bolted through the roof supports the gimbal ring mount for the transmitter dish. This is directed at the receiving dish at the 75-ft. level on the transmitting tower 4.6 miles away.

In the penthouse are the transmitter control, mobile unit receiver control, phone company clamp amplifier, video switching

facilities, spare tubes, instruction books, fuses, tools, telephone, Master Voltohmyst, RCA WO56A Oscilloscope, and off the air monitor. The penthouse roof is now utilized as a tripod base for the mobile unit receiver dish.

Use such as this of an unattended microwave transmitter does of course introduce an element of uncertainty in tracing net-

FIG. 4. Early plan of the WJTV Building showing location of technical facilities.

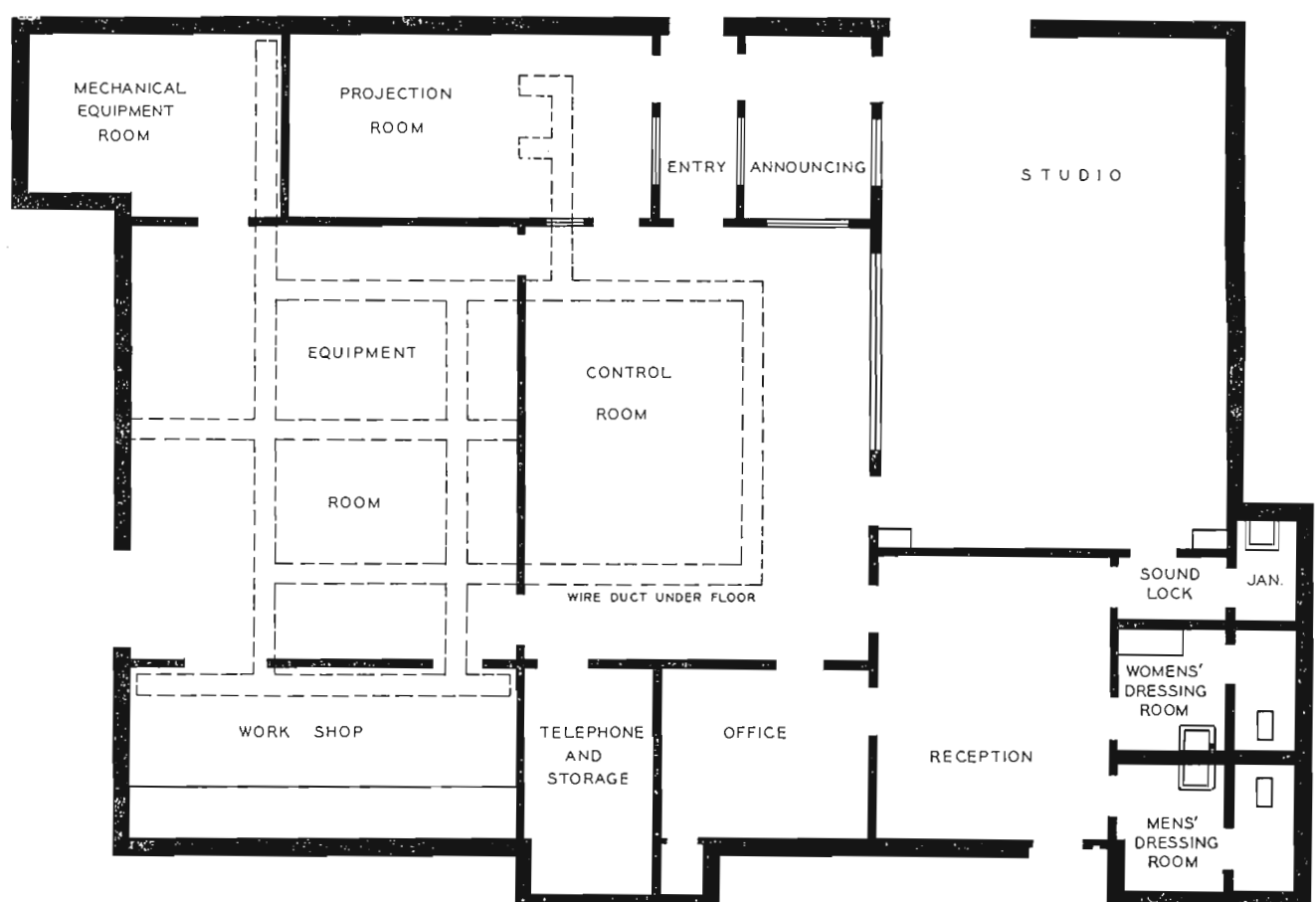

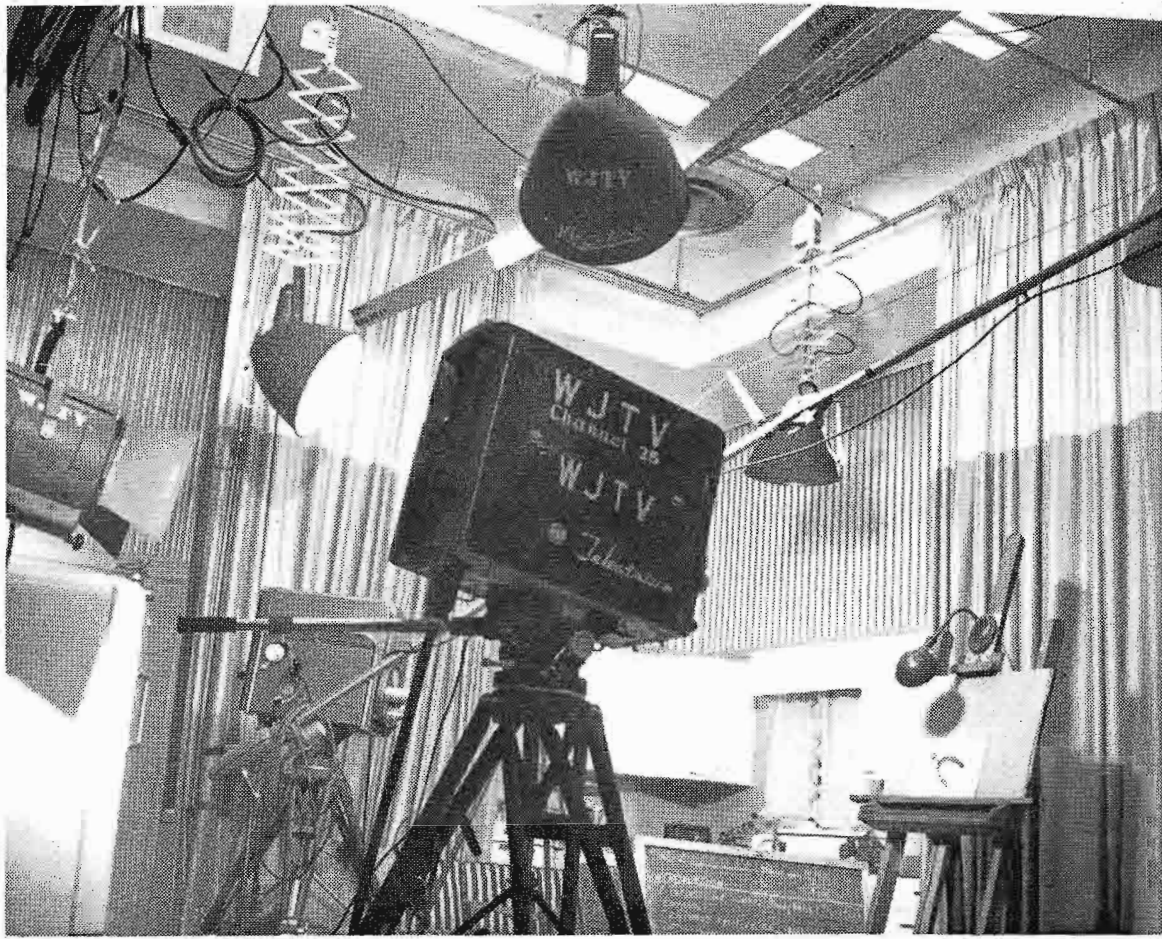

FIG. 5. View of a corner of the WJTV studio which shows a typical lighting and camera arrangement.

work trouble in conjunction with the Bell people due to the fact that in normal operation the station operating personnel are viewing only the microwave output, and not its input as well. However, the overall operation for the past year has been quite satisfactory, due to the simplicity and reliability of the RCA microwave transmitter. This gear at the penthouse is run continuously, 24 hours a day, and a monthly tube check has sufficed to provide an excellent service record.

RCA Mobile Unit Provides Public Demonstrations and Promotion

A completely equipped RCA mobile unit was obtained in November 1952 and was immediately put to use (in the midst of transmitter and studio construction and planning) in public demonstrations and promotions. This included field trips with stops at every town, hamlet and crossroads within a 40 mile radius of Jackson, suitably publicized before and after in both local newspapers.

Since going on the air this mobile unit has seen service every week in direct pickups of sports events, religious services, governmental functions from the state capital, patriotic affairs, parades, fund-raising events, and the like.

Transmitter Building

Going back for a moment to the transmitter building. Stakes were driven to establish its location and work begun in early October, 1952. The construction is masonry, Roman brick exterior, supported

on 20 foot concrete piling with $3\frac{1}{2}$ foot grade beams. Floors are concrete with asphalt tile covering, walls of painted plaster, acoustical ceilings in control room, studio, offices, announce booth, reception room and projection room. Acoustical walls in control room, projection room, announce booth, and studio; this last being the new perforated Reynolds aluminum covering 2 inch rock wool. All acoustical windows of $\frac{1}{4}$ plus $\frac{3}{8}$ plate glass. Ample trenching

system is provided in control room and transmitter room, connecting with projection room, shop, studio, and two equipment rooms for airconditioning, telephone facilities, etc. Trenches are 12 x 12 inches, to provide a trench system with ample room. They have metal edges and covers, and contain 8 foot $\frac{5}{8}$ inch copperweld ground rods at 4 foot intervals, using a total of 47 ground rods which are connected by a continuous 4 inch 30 mil copper strap all silver brazed together.

This system is in turn connected to the copper-covered concrete tower base and its associated 50 foot ground radials with an 8 foot $\frac{5}{8}$ inch copperweld ground rod at the end of each. These radials are 40 in number and extend in a 90 degree fan from the base.

The trench system connects with the studio by means of 3, 3 inch conduits terminating in a 9 x 16 x 12 inch deep floor box, which in turn extends to the opposite side of the studio with three more 3 inch conduits.

The walls are liberally lined with one inch conduit terminated in outlet boxes at baseboard and ceiling height for concealed wiring to speakers, monitors, clocks, signal circuits, microphones, and so forth.

Lighting

The studio ceiling is provided with a pipe grid, used to support studio lighting units on counterbalanced spring hangers, controlled by Kleig switch board. Lighting

FIG. 6. (Left to right): John Hollingsworth, R. K. Somers and S. J. Parks, engineers at WJTV, posing behind RCA TC-4A Audio/Video Console.



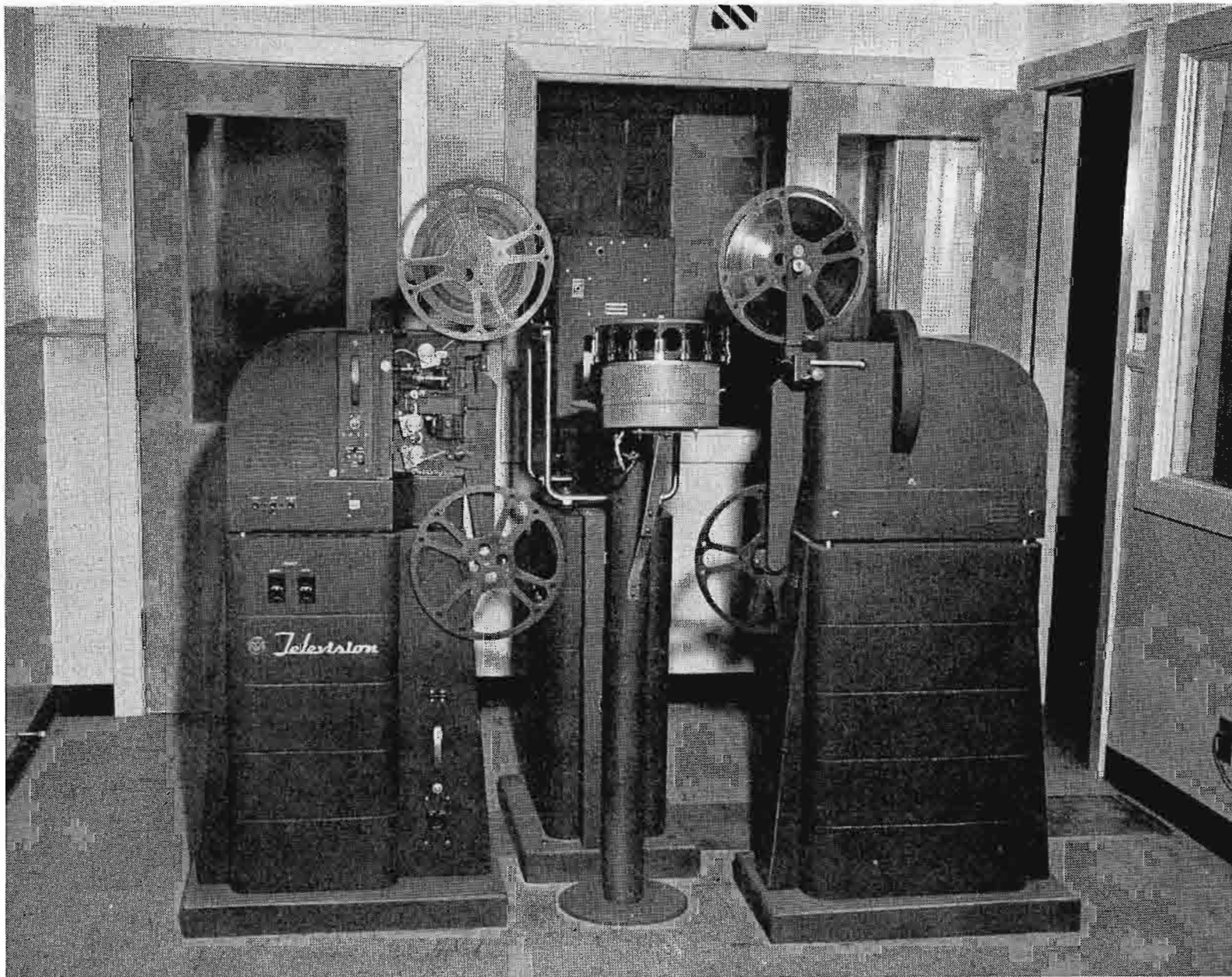

FIG. 7. View of the WJTV film projection room showing the use of RCA 16mm projectors, TK-20 film camera, and automatic slide projector.



mains to the rather small studio consist of 4 number 4 wires.

Expanded Facilities

In the middle of 1953, realizing that the operation had outgrown its original Basic Buy equipment, the TC4A gear was superseded by complete studio gear including a TS10A fader and switcher, BC2B sound console, TA1A distribution amplifiers, TS1A line switcher, and so on.

Also in this same period WJTV received shipment of the new Studio Zoomar, serial number 001.

This smooth working versatile instrument has proved invaluable in the close quarters of the studio as well as for mobile pickups of baseball, parades, and special events.

Programming Facilities

In November 1953 a TSC Profitmaker rear screen projection outfit was purchased and has proved to be a valued adjunct to programming and serves to minimize the twin problems of scene shuffling and storage.

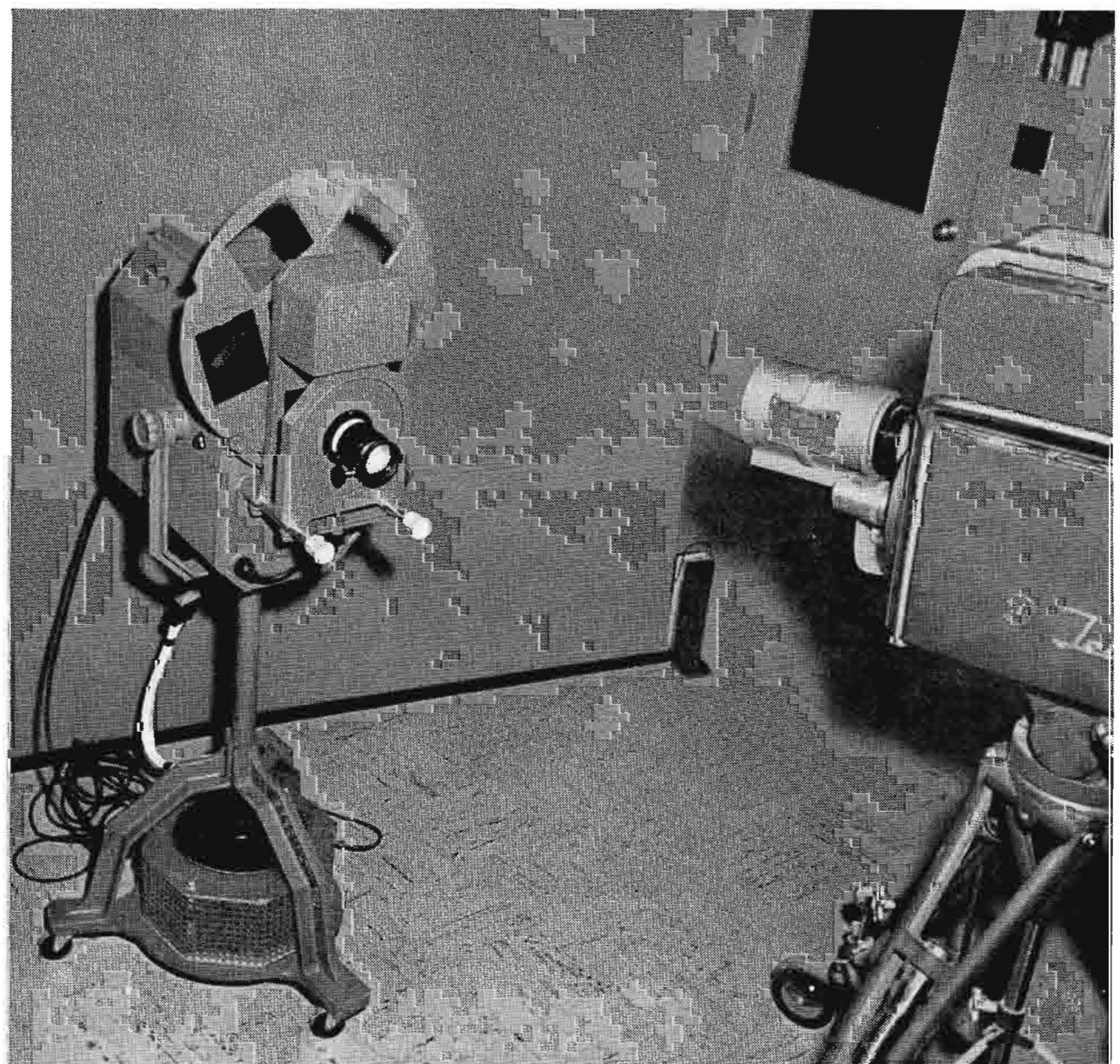

FIG. 8 (at right). View of the WJTV rear screen projector and TK-11A Studio Camera equipped with Studio Zoomar.

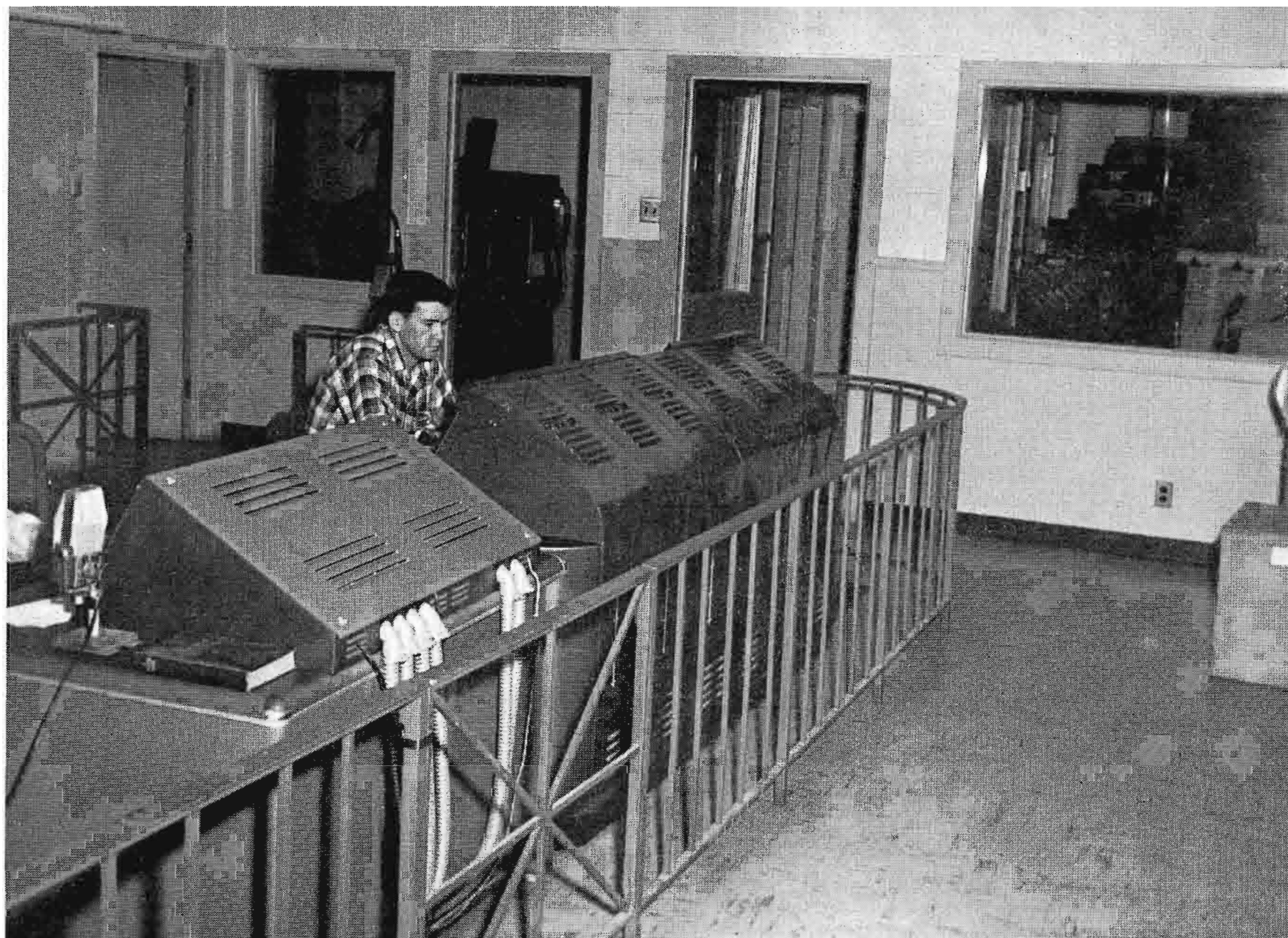

FIG. 9. WJTV's most recent control console arrangement which has a fence enclosing the operating area. Visible also is the projection room, sound lock, announce booth. Shown at the BC-2B consolette is R. K. Somers, WJTV Engineer.

Fast production of neat title cards is obtained with a Line-O-Scribe printing outfit, which has been quite helpful.

The building was also expanded to provide office space for the Manager, production, sales, general office, and a new reception room.

These additions and expansions of the programming facilities and conveniences were welcomed by the program and sales departments and by agency people and sponsors.

At the present time WJTV goes on the air with test pattern at 10 AM Monday thru Friday, programming begins at noon and runs until 10:30-12:30 PM. Saturday morning programming at 9:00 AM continuing until 11 PM. Sunday schedule 11 AM with remote church service via mobile unit and signoff around 11 PM.

With a five day 40 hour work week this operating schedule is handled by an engineering staff of nine men supervised by Assistant Chief Engineer S. J. Parks. Also included under the Chief Engineer are the two girls in the film department and two men hired as night watchmen and building maintenance. With the exception of one man, each engineer has a Radiotelephone First license, together with AM broadcast experience, and all are natives of Jackson or surrounding area.

The one-man photographic department turns out 2 x 2 slides and rear projection slides. His dark room includes a 4 x 5 Speed Graphic, 35 MM Exacta, flash attachments, Polaroid back for the Graphic, tanks, trays, copying stand, racks, lights, etc.

Two RCA type 400 projectors are available, one assigned to the film department and one to sales.

Other film department equipment includes two viewers, two rewinds, and one sound reader, as well as suitable racks, cabinets, industrial steel shelving, frames, editing table and a work bench.

Tower and Antenna

The tower, provided and erected by Andrews Towers, Fort Worth, was chosen to be only 18 feet from the building for minimum transmission line loss. The base is 378 feet above M.S.L., tower height overall 671 feet, radiating approximately 750 feet above average terrain.

The antenna, an RCA TFU21BL, is set up with a 0.4 electrical tilt, and a 0.4 mechanical tilt favoring Jackson. The transmission line is 6 1/8 teflon, with the exception of single 3 1/8 lengths at top and bottom of tower, and a 3 1/8 horizontal run for vertical

FIG. 10. Side view of the video operator's position. Video test and power supply racks are visible.

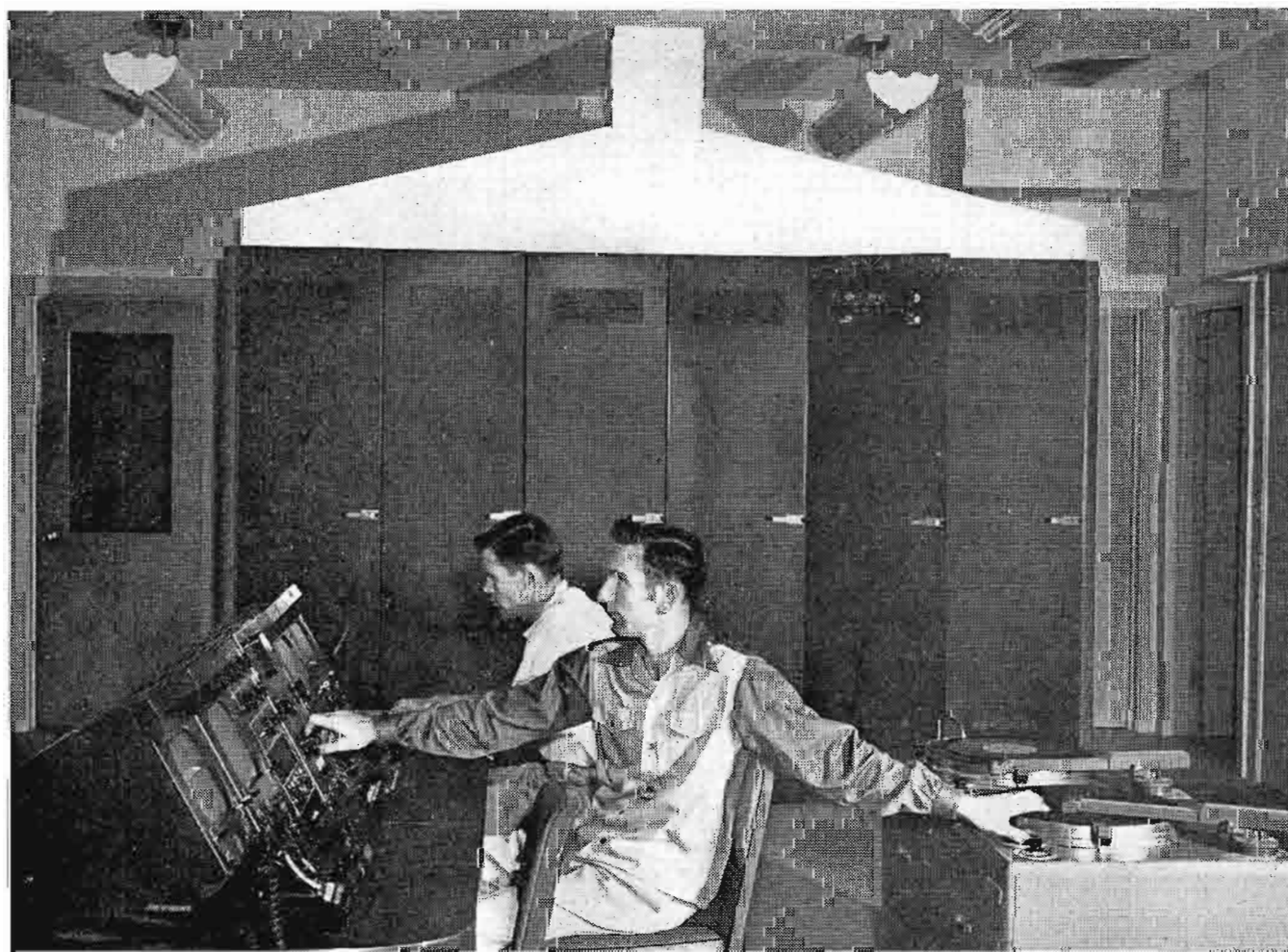



FIG. 11. View of the WJTV transmitter room showing the RCA TTU-1B, 1 KW UHF transmitter and partial view of the console. Note that provision is made for addition of RCA high power amplifier. Harold Townsend is shown at the transmitter and R. K. Somers at the console.

flexibility. The transmission line is run inside the tower, and the tower is climbed from the inside.

Space Planned for Future Expansion

Adequate space was provided in the transmitter room for a possible 50 KW transmitter, and temporary panels are in place at each end of the present 1 KW transmitter which will be removed and replaced by the 12.5 KW amplifier cubicles. Transmitter cubicles are flush wall mounted with fluorescent panel lighting.

Transmitting Equipment

All equipment cubicles and racks in transmitter and control room are enclosed to the ceiling and ducted to the roof, the auxiliary racks being furnished with a 300 cubic foot blower for exhaust. This arrangement serves to keep door, panel, and equipment temperatures down to a reasonable value, and removes a portion of the load from the airconditioning system.

The Filterplexer

The filterplexer is bolted direct to ceiling in inverted position for maximum accessibility at trombone elbows for test and power calibration.

Power Facilities

All 60 cycle power circuits are taken from a 125 KVA transformer bank, run

to building in underground conduit through dual paralleled runs of 350 M circular mil cable, to a 600 amp. main breaker, thence to distribution system. Regulation is excellent. A larger transformer bank will be installed coincidentally with the 12.5 KW amplifier.

The building, grounds, and tower are flood lighted, with large neon call letters on the tower.

Airconditioning System

The airconditioning system provides 32 tons cooling capacity, and introduces cooled or warmed air as needed.

Maintenance

Maintenance shop tools include hole saws, socket punches, Presto torch set for silver brazing, numbered drill set, $\frac{1}{4}$ inch Thor drill, Sioux high speed tool grinder, precision level, taps and dies, besides the usual complement of wrenches, pliers, screwdrivers, etc.

Shop instruments include a Tectronix 524, Jones Micromatch, RCA Video Sweep, RCA Master Voltohmysts, RCA WO56A scopes (with one each of the last two items at the microwave STL location, together with tools), RCA Low Distortion Oscillator, RCA Noise and Distortion Meter,

RCA gain set, Dummy Load and Wattmeter, and Side Band Analyzer.

Preventive maintenance consists mainly of tube checking, along with other items such as vacuuming and blowing, cleaning, checking nitrogen pressure, dry air pressure, checking all meter readings, taking inventory of all tubes, fuses, and bulb types. The department includes something over 1300 tube sockets, and regular testing of these with the Hickok as well as the other tasks outlined is facilitated by means of a card system.

Each day a card is pulled which outlines tasks to perform. These jobs are done and the card dated and signed by the engineer who pulls it. The cards are numbered and arranged so that the different functions are taken care of at weekly, semi-monthly, or monthly intervals as required.

RCA Color Equipment

Some months ago an order was placed with RCA for one of the first batch of Group A gear, comprising the Color Network Operating Equipment. Some of this gear has been delivered, and as this is written the writer and Assistant Chief Parks have just completed the setting up and convergence adjustments of the first RCA Tricolor Monitor in the South.

NEW 12¹/₂ KILOWATT UHF TRANSMITTER

Extended coverage is for many UHF TV stations the most direct way to an improved economic position. The obvious advantage of a larger audience can now be had with the introduction of RCA's new TTU-12A transmitter. Built on a firm foundation of experience gained with nearly 100 successful UHF 1-KW transmitter installations, the newly designed equipment makes any of these 1-KW stations eligible for easy conversion to high power.

At the same time, the new 12¹/₂-KW transmitter is a completely integrated equipment for the most critical purchaser of an entirely new installation. Two matching cabinets added to the TTU-1B transmitter enclose aural and visual high power

by **R. L. MEISENHEIMER**
Broadcast Transmitter Engineering

amplifiers. Four more cabinets also of the same style include the high power rectifier, control, and associated circuitry.

The photographic view, Fig. 1, shows the front panel arrangement of the TTU-12A transmitter equipment. The three center cabinets will be recognized as the TTU-1B transmitter, which are flanked by aural and visual PA cabinets. At the left-hand end is the main control cabinet for the power amplifiers. At the right hand end is an auxiliary control cabinet. Two additional cabinets of the same style enclose

power supply equipment and are mounted separately.

A "Proved-in" 1-KW Driver

Although any transmitter furnishing an equivalent 1 KW of driving power might be used with the power amplifiers described, the equipment comprising the TTU-12A transmitter is carefully integrated to give a maximum of satisfaction with the TTU-1B equipment as a driver. The TTU-1B has been installed and performance proved in numerous stations throughout the nation. The reader's attention is invited to an earlier article¹ describ-

¹"The TTU-1B 1 KW UHF TV Transmitter," by T. M. Gluyas and E. H. Potter, BROADCAST NEWS, Vol. No. 74, May-June, 1953.

FIG. 1. Full front view of the RCA 12¹/₂ KW, UHF Transmitter which is comprised of seven cabinets mounted "in-line". From left are: Main Control, Aural "P.A.", Aural Driver, Driver Control Section, Visual Driver, Visual "P.A.", and Auxiliary Control. Rectifier, Thyatron Unit, Water Cooler, and Plate Transformer are usually mounted behind transmitter in a nearby area.

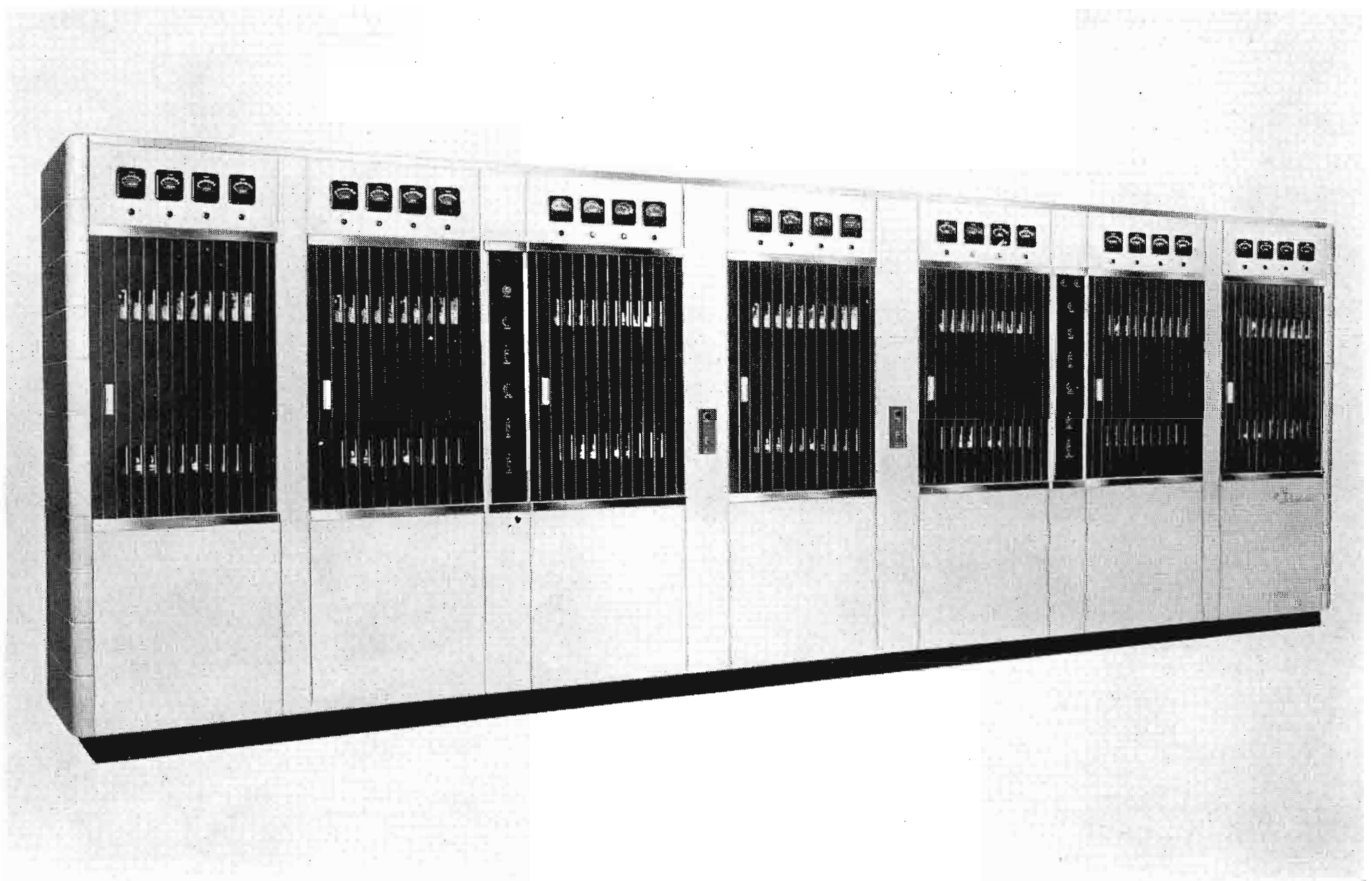

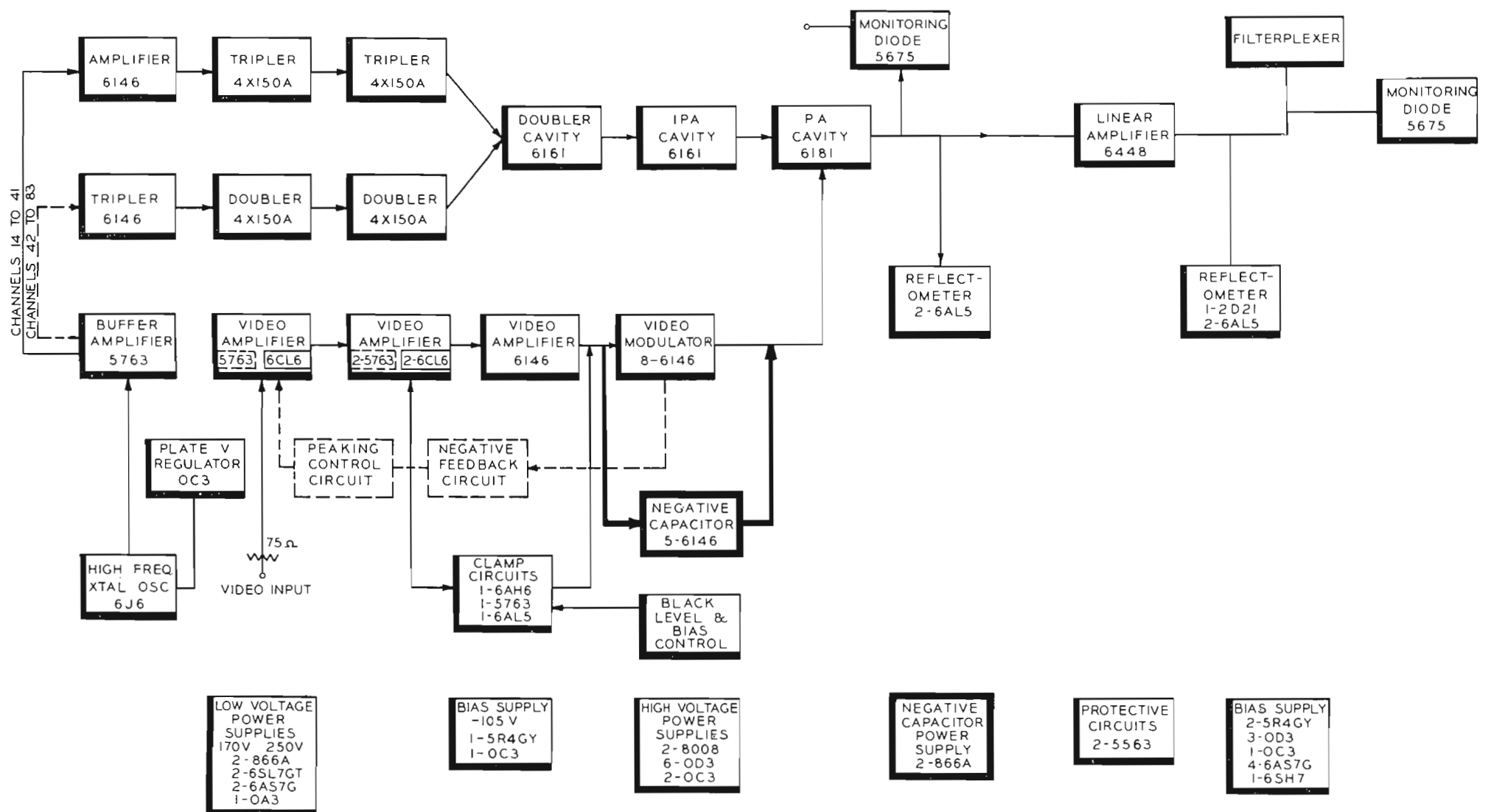

FIG. 2. Simplified block diagram showing the visual portion of the 12½ KW UHF Transmitter, TTU-12A.

ing the TTU-1B transmitter in detail. The block diagram, Fig. 2, shows a tube lineup of the TTU-12A transmitter.

Designed for Color

The TTU-12A transmitter is the result of several years' intensive development work. During the period while this transmitter was being designed, several important color television technical facts became known. These discoveries indicated the need for higher performance standards for color TV than for monochrome transmission. Therefore much additional design effort was expended in satisfying the closer tolerance on video frequency response, achieving near perfect linearity, and obtaining close control of subcarrier phase vs. amplitude.

Why a Conventional Beam Tetrode

After careful study and evaluation of all methods for high power generation at UHF, the beam tetrode (RCA 6448) was selected by RCA as offering the following outstanding advantages.

1. Economy of operation—because as a conventional linear amplifier the power input to the visual amplifier varies according to the signal content thereby taking advantage of a normal low average value of the visual program for power savings.

2. Conventional circuitry—tuning is limited to two simple tuned circuits in the power amplifier.

3. Compatibility with color TV transmission standards—exhaustive tests have been made which insure performance that exceeds the new requirements for color TV transmission.

4. Tube change ease which stems from the compact lightweight tube (25 pounds).

5. Building block feature which permits a broadcaster the choice of starting up with a 1-KW transmitter and adding the high power equipment later.

The newly announced RCA 6448 is the heart of the high-power amplifier in the TTU-12A transmitter. The tube, shown photographically in Fig. 4, is a beam tetrode especially designed for service in the TTU-12A transmitter. It is composed of 40 beam tetrode sections of short length arranged with thoriated tungsten filament on the outside progressing toward the water cooled copper anode at the center. Compact design which is so necessary for efficient UHF operation is made possible through water cooling of the anode and also the several connections to other elements within the tube. Internal RF by-passing between screen and cathode makes possible grounded filament operation. High power

gains of the order of 15 are accomplished in a broadband amplifier employing the 6448. Careful attention to screening within the 6448 makes this amplification possible in the UHF television band without resorting to neutralization.

The TTU-12 Power Amplifier

A complete amplifier assembled with the 6448 tube and being rolled into place in the visual PA is shown in Fig. 5. Input and output tuned circuits are assembled with the tube and are pretuned under power for optimum performance. After rolling into place from the tube change dolly, connections to the unit are completed by attaching five water snap connectors, three filament leads and the r-f input and output connections. A single multi-conductor plug completes the interlock connections simultaneously with filament voltmeter leads. A special heavy duty union has been devised for the power output coaxial which permits rapid connection to the output line without spring contacts. Plate and screen grid voltages are automatically connected when the amplifier is rolled into place within the cabinet.

The diagram, Fig. 3, is useful in gaining an understanding of the RF circuits which comprise the TTU-12A amplifier. Modulated RF input from the exciter is coupled to the input tuned circuit through the

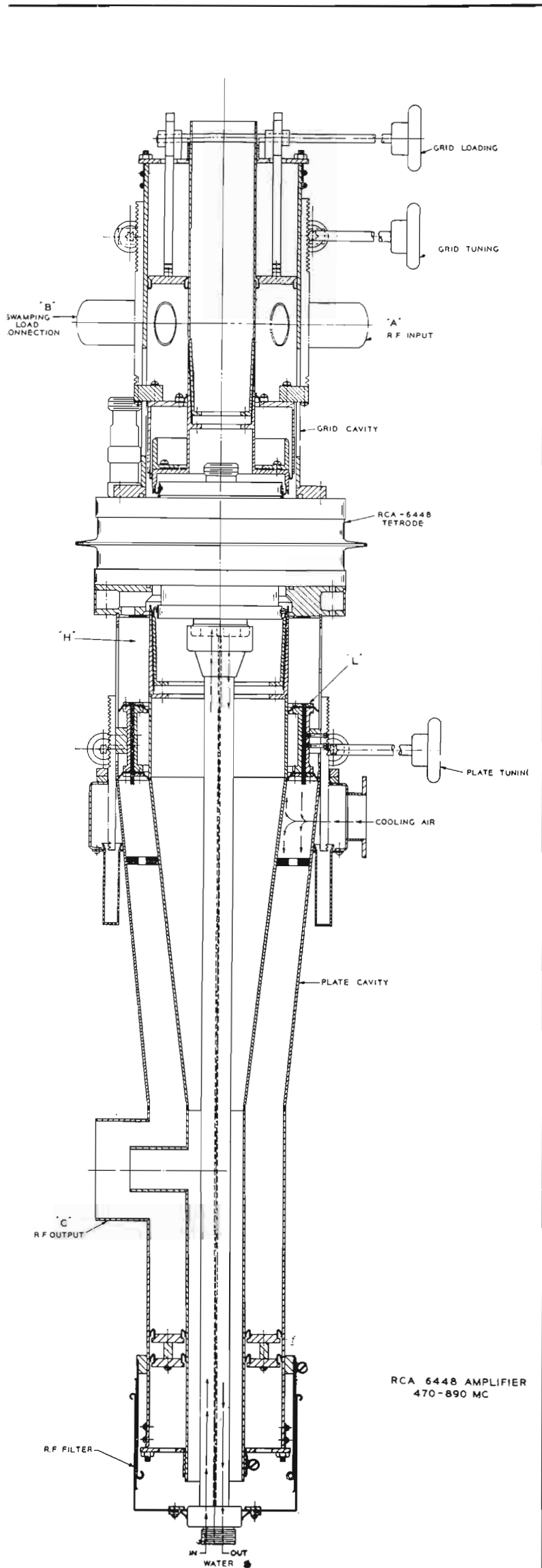

FIG. 3. Cross-sectional view of the 6448 tube and cavity. Note the rugged, simplified mechanical arrangement which results in simplified tuning—and easy handling because of the small overall cavity size.

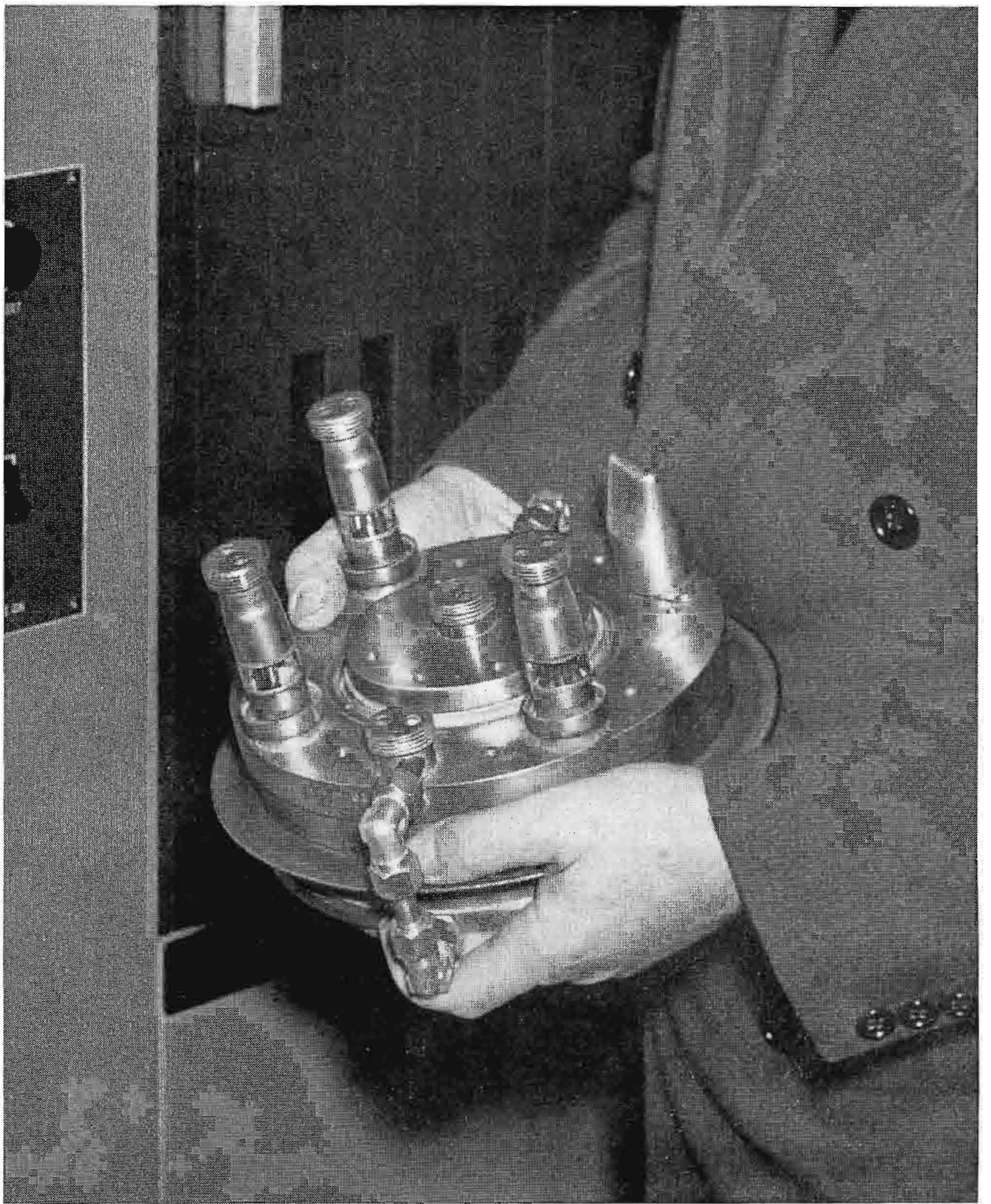

FIG. 4. Closeup view of the new small-size, RCA 6448 used in the TTU-12A Transmitter. The same conventional tube (RCA Type 6448) is used in the Aural and Visual "P.A." Use of conventional types of tubes throughout results in economical operation, easy maintenance, and simple, straightforward circuitry.

transmission line at "A". The resonant circuit formed by the coaxial elements connected to grid and cathode is tuned to the carrier frequency. A second coupling element at "B" associated with the grid resonant circuit removes a portion of the exciting power which is then dissipated in a swamping load resistance. The result of this deliberate wasting of RF power is a useful broadening of the video frequency response of the grid tuned circuit. A typical condition of operation is one utilizing 800 watts total peak power from the TTU-1B of which 350 watts peak is transferred to the swamping load while the remainder, 450 watts, is consumed in circuit losses and driving power.

The plate-tuned circuit composed of coaxial elements is also shown diagrammatic-

ally in Fig. 3. Here the useful power output to the load through output connection "C" serves to broaden the video frequency response of the tuned circuit. The resonant circuit proper is $\frac{1}{2}$ wavelength long electrically. A low impedance section designated "L" constitutes, approximately, the second $\lambda/4$ and by virtue of its sliding contacts and mechanical drive, constitutes the tuning element in the plate resonant circuit.

The $\lambda/2$ electrical circuit is employed here to facilitate tuning and output coupling at the highest frequencies. The radical changes in surge impedance between 1st and 2nd $\lambda/4$ sections minimizes total stored energy in the circuit and hence gives greater bandwidth than a uniform impedance circuit of the same electrical length. The surge

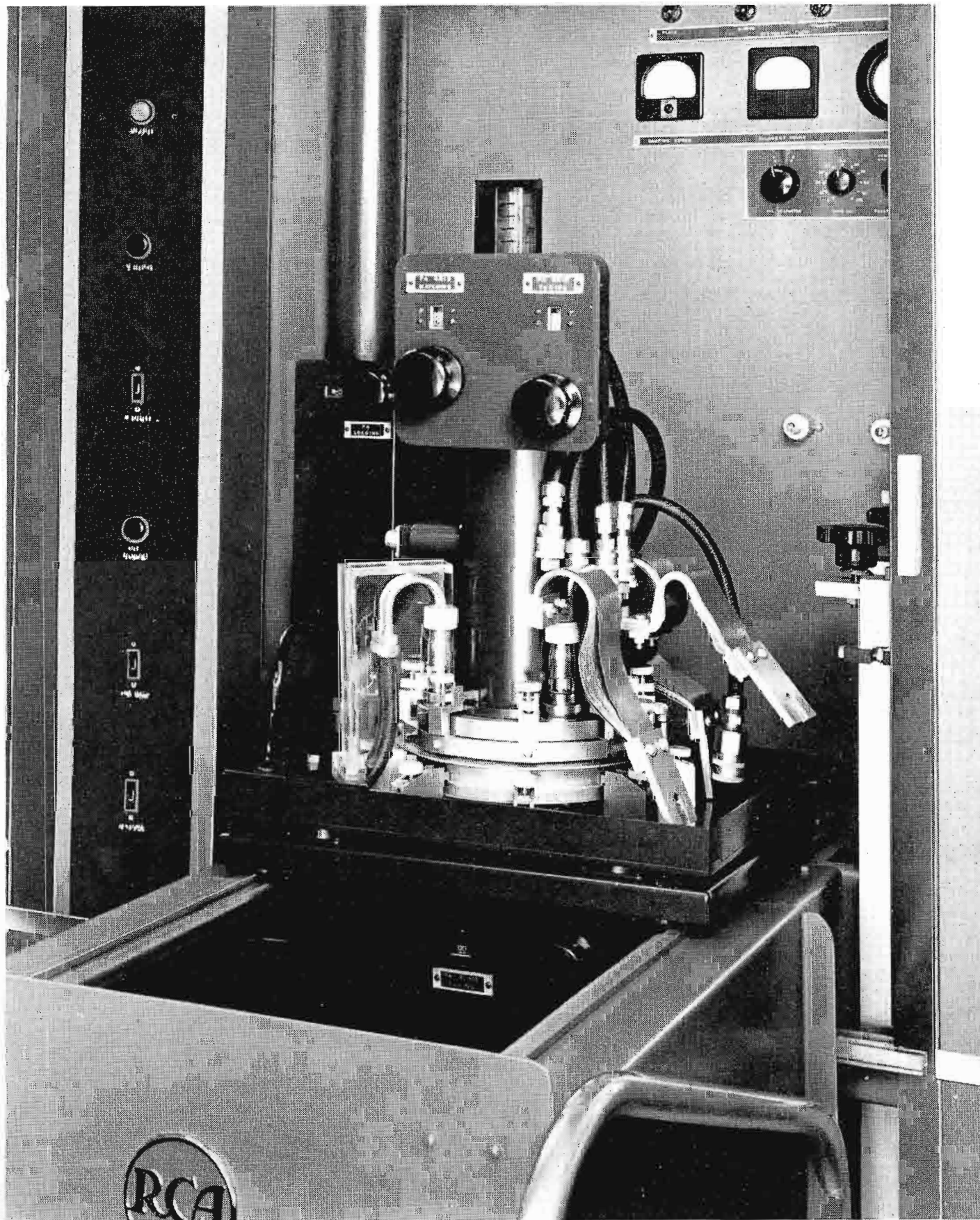

FIG. 5. A spare "P.A." cavity, supplied as a part of the transmitter, simply glides from a dolly into proper position in the P.A. cabinet. Compactness of the tetrode and unique cavity construction permits the operator, unassisted, to replace the complete final stage with an auxiliary amplifier within five minutes.

impedance in the high impedance portion of this circuit designated "H" is approximately 23 ohms. Teflon dielectric is employed in the 2nd $\lambda/4$ low impedance portion, "L", resulting in 2 ohms surge impedance.

The taper section transforms from 23 ohms impedance to 50 ohms impedance and reduces the large diameters necessary around the tube to near the standard transmission line size.

At the right angle connection to the transmission line, the 50 ohm standard

FIG. 6. The RCA 6448 tubes and cavities can be moved about and interchanged—safely and conveniently—by means of a movable dolly which is furnished with the transmitter.

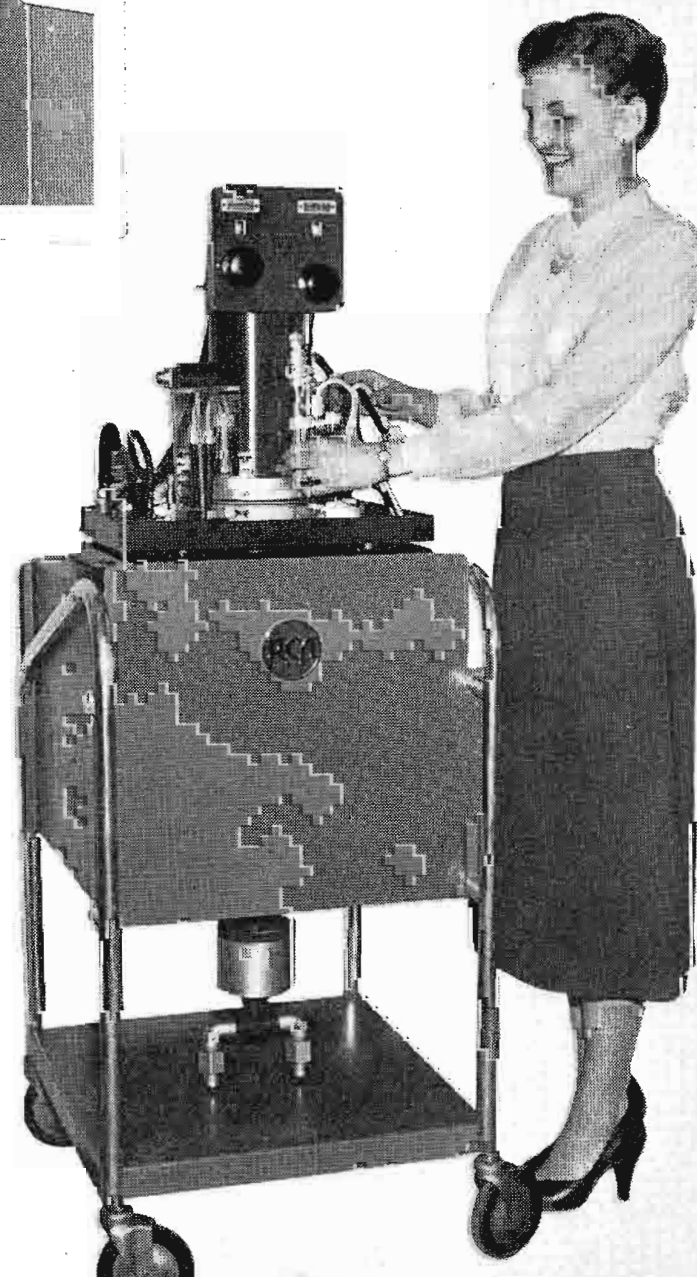

$3\frac{1}{8}$ inch UHF line begins and is continuous through the loading transformer to the filterplexer. At the right angle connection an adjustable stub extends for $\lambda/4$ in line with the cavity axis for the purpose of bringing out the water pipe connections from the anode.

Since a certain amount of UHF energy is propagated through the plate blocking capacitor, an additional electrical trap is formed by the water pipe inductance and a filtering capacitor at the lowest extremity of the assembly where the water pipes enter the cavity.

The photograph Fig. 7 shows the amplifier unit in position within the power amplifier cabinet. The lower front panel is removed to expose details of the bottom compartment. Visible on the right side are the filament supply leads from filament transformers mounted in the rear of the PA cabinet. The flexible leads from the amplifier assembly are secured by pressure clamps to these filament leads as shown. Also shown properly connected are the snap type water disconnects.

The high power output $3\frac{1}{8}$ inch diameter UHF coaxial is visible extending from the plate tuned circuit toward the left side of the cabinet. Immediately above the elbow in the vertical run is located the power amplifier loading adjustment. This device is a variable transformer which presents to the amplifier plate tuned circuit an adjustable resistive RF load impedance. Because bandwidth is proportional to load-

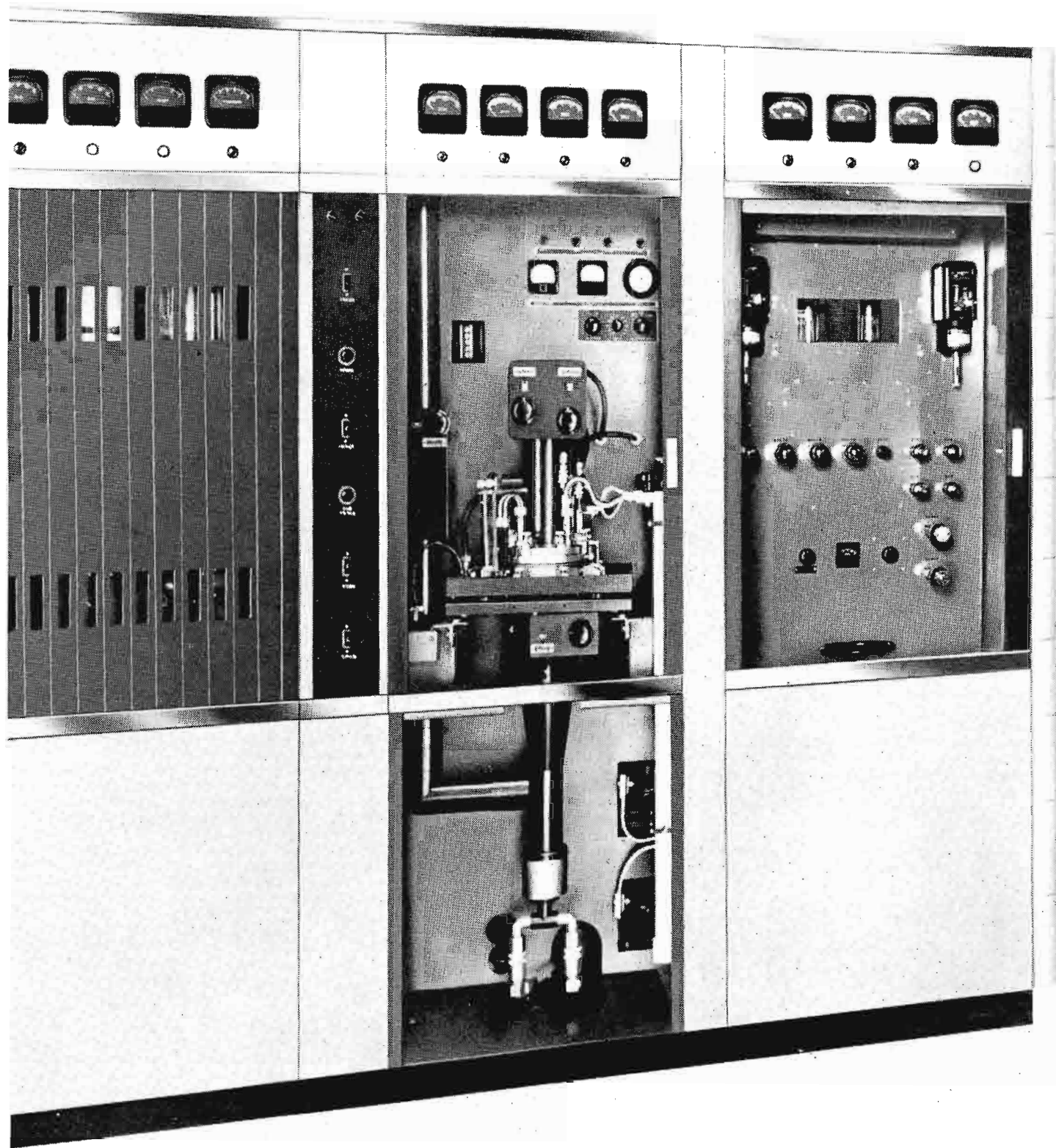

FIG. 7. Closeup view of right portion of the TTU-12A Transmitter showing the "P.A." cavity mounted in place. Cabinets are from left: Visual R-F Driver, Visual "P.A." Unit, and Auxiliary Control Unit.

ing, this control sets the bandwidth of the output resonant circuit. This is not a tuning control; once adjusted for a given frequency, power, and bandwidth, this control requires no further attention.

Visible on the panel immediately behind and above the amplifier, reading from left to right are the plate water flow indicator, swamping load power indicator, 6448 filament hour meter and the outgoing water temperature meter. Reflectometer controls are also located on this panel.

Indicator lights are provided to show the condition of each interlock associated with the cooling circuits in the power amplifier cabinet.

Rectifier and Power Supplies

Many of the remaining benefits of the TTU-12 engineering design fall into patterns established by many other successful RCA transmitter designs. For example, DC power supply from common plate and screen rectifiers is an economy feature incorporated in other RCA transmitters and carried over into the TTU-12 design.

Electrical power supply to the 6448 amplifier filament is two phase at 1.35 volts,

FIG. 8. Simplified diagram showing the Thyatron Circuit used in the TTU-12A for protection of power tubes and equipment. Protection is achieved in less than ten microseconds, and (for demonstration purposes) when a .500" diameter wire is placed directly across the 7000 volt supply—no physical change is experienced by the wire because of rapidity with which protective circuit works.

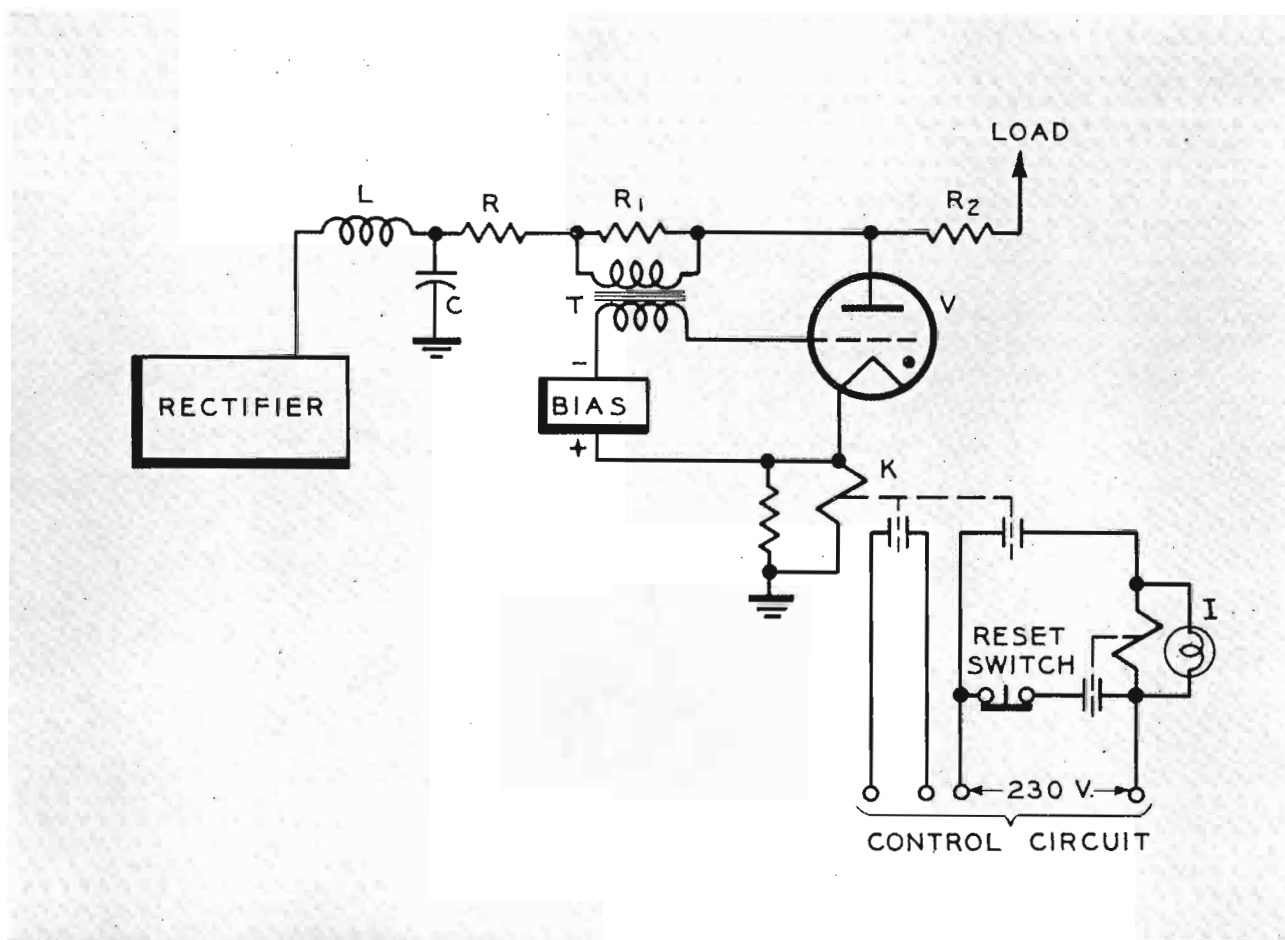

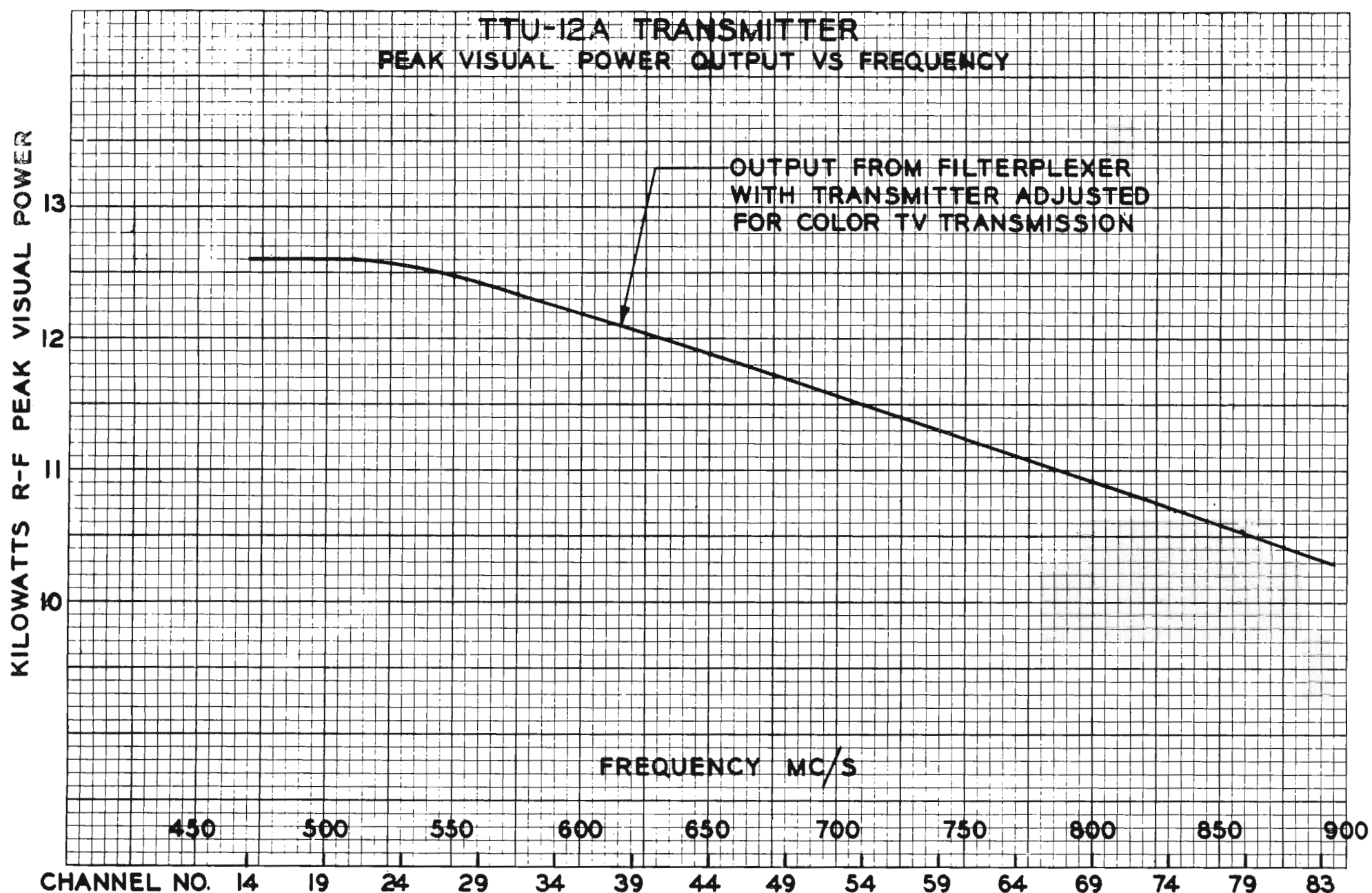

FIG. 9. Curve of the TTU-12A Transmitter peak visual power output vs. frequency.

1000 amperes per phase. The high current accounts for the large bus bars apparent in the photograph, Fig. 7. Reactance phase splitting of a single phase regulated source is employed. Regulated bias is supplied to the visual power amplifier from the auxiliary control unit. Plate and screen voltages of 6,000 volts and 1,000 volts respectively are supplied from rectifiers that are common to aural and visual transmitters.

Three single phase transformers filled with non-inflammable synthetic oil supply the plate power for the PA units. These units are suitable for mounting without a protective enclosure in the transmitter room or an adjacent area. In the main rectifier cabinet are seven RCA 5563-A rectifier tubes. The six active 5563-A tubes are connected with the external plate transformers in a 3-phase, double-wye circuit, supplying both aural and visual plate power. The seventh tube is maintained in a heated condition for immediate service as a replacement.

Three additional RCA 5563-A tubes are used in high speed protective circuits. In this service they are normally biased beyond cutoff, but on occurrence of a fault in

a high voltage circuit, such as an r-f tube gas arc, the 5563-A thyratron reacts within 10 microseconds to protect the circuit until primary power is removed.

Metal duct work is furnished for enclosing the high voltage circuits between transformers and rectifiers. The interphase reactor, essential to operation of the double wye rectifier, is mounted adjacent to the transformers and is connected via the same high voltage wiring duct.

The auxiliary equipment supplied is carefully engineered for easy installation by the customer. A factory made, preformed wiring harness is provided for all installation connections which can be predetermined.

High Speed Protection

A simplified circuit of this important feature is shown in Fig. 8. Capacitor C in this figure represents the filter capacitor on one of the high voltage circuits. In its fully charged condition this capacitor possesses a considerable amount of stored energy especially in the video circuits where large values of C are necessary. In addition the power supply rectifier, in the event of a high voltage overload, continues to fur-

nish energy to the circuit for an appreciable period of time due to the slowness of electro-mechanical protection devices. In the arrangement shown in Fig. 8, R_1 is a "sensing resistor" which, in the event of a sudden overcurrent in the load circuit, transmits a steep wave front positive pulse through transformer T to the grid of thyratron V which is normally biased off. This event results in immediate ionization (within 10 microseconds) of the tube V which then conducts and forms an effective short circuit parallel to the load.

Energy stored in C and that which is subsequently furnished from the power supply is dissipated in resistors R and R_1 , while, since R_2 has a large value compared to the resistance of the ionized thyratron, very little current flows to the faulted load.

Conduction of the thyratron operates relay K which is a conventional overload relay. This results in opening of the primary contactors in the usual fashion.

The above described circuit is repeated three times in the thyratron unit. Indicator lights on the meter panel show which tube has functioned in case an overload occurs in one of the circuits.

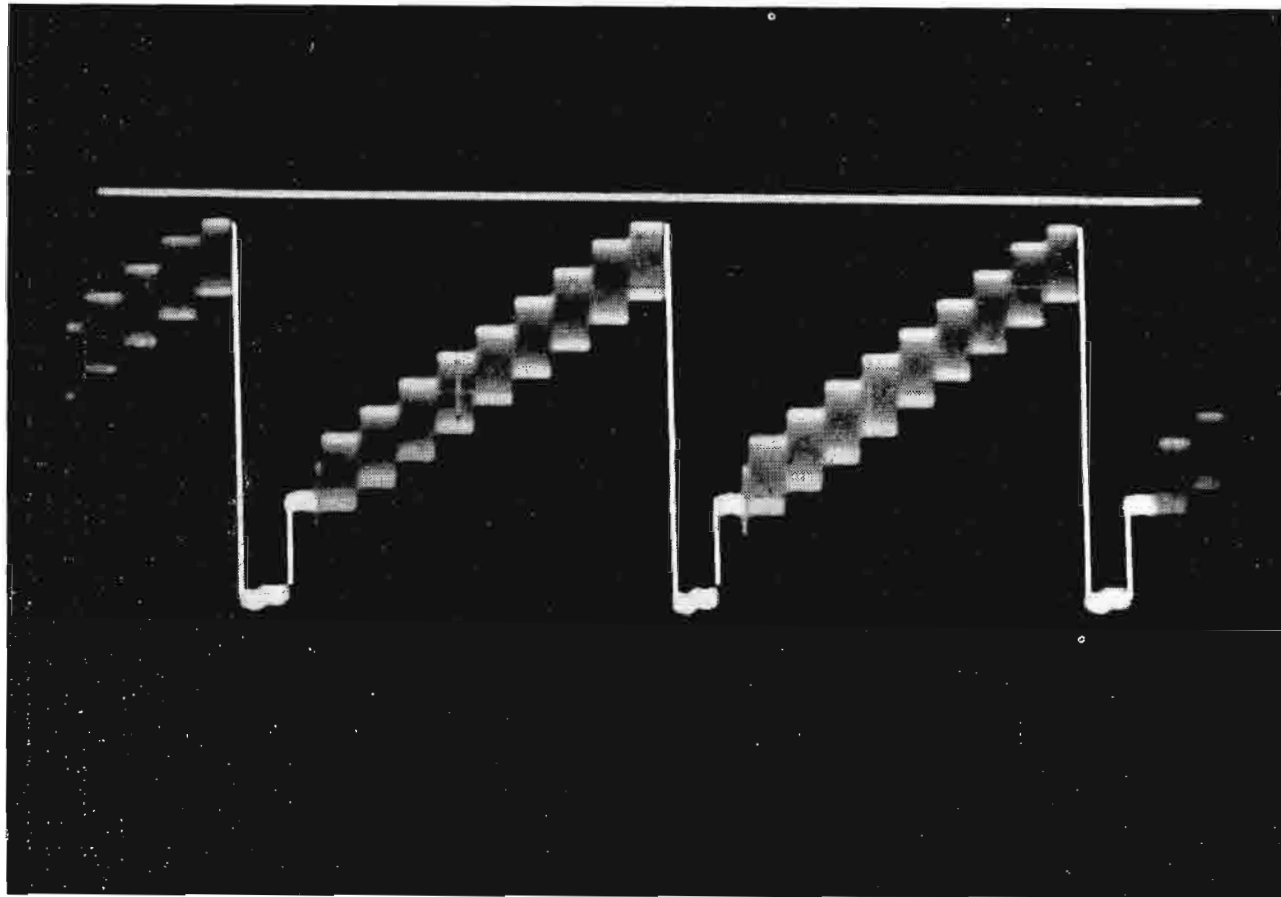

FIG. 10. TTU-12A output step-wave, channel 59, 11.3 KW output.

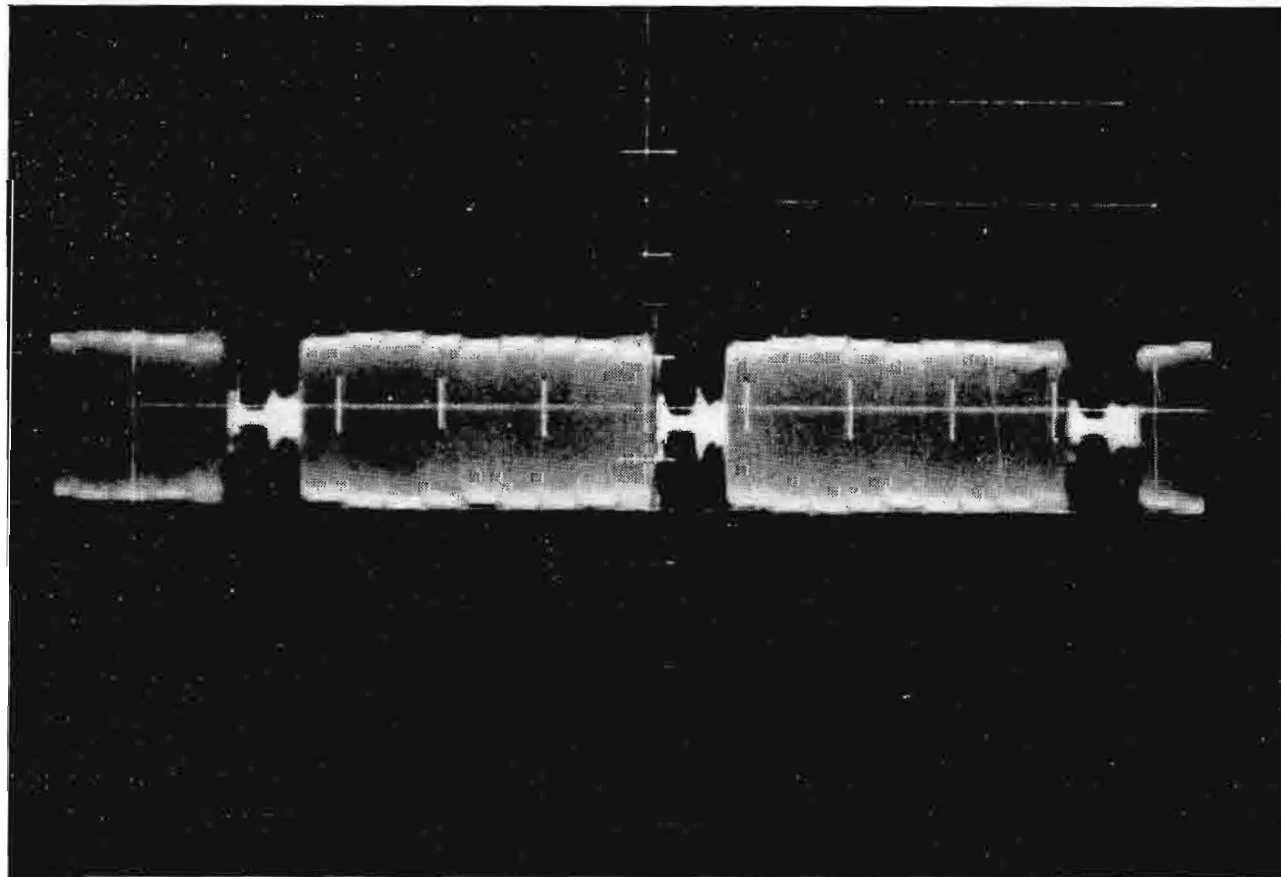

FIG. 11. TTU-12A output, color sub-carrier incremental gain, channel 59, 11.3 KW output.

High voltage plate and screen filter components are enclosed in the main rectifier and thyatron cabinets.

Power Switchgear

Furnished with the transmitting equipment are all the necessary power switchgear items for operating the transmitter from a 208/230 volt supply. These are designed for wall mounting to provide extreme flexibility of installation details for individual stations.

Transmitter Control

Complete transmitter control is provided from the standard TTC-1B console if desired. This is accomplished through circuits to the main control cabinet shown photographically at the left end of the transmitter, Fig. 1. TTU-1B exciter power circuits are supplied through this main control when existing 1 KW stations are converted to high power. Starting and stopping the transmitter, overload indication, overload resetting, and time delay by-passing can be accomplished from the console or from either of the vertical control panels adjacent to the PA units.

High voltage transfer switching which removes either of the power amplifiers from the common high voltage supplies is accomplished by contactors located in the main rectifier cabinet. These contactors are controlled by a switch located in the main control cabinet. The individual PA filters and H.V. supply connections are automatically grounded unless switched to the "on" position. Indicator lamps in the main control cabinet show the condition of the switching.

Complete interlocking protection is provided throughout the TTU-12A transmitter for equipment and personnel protection. Automatic HV shorting switches are provided in the PA compartments. Additionally, grounding sticks are provided at all points where required for the safety of station personnel.

Overload protection is provided on all circuits in which destructive fault conditions could occur. Reflectometers in both aural and visual transmission lines remove transmitter power if the VSWR exceeds a predetermined value.

Performance

Since circuit efficiency and tube efficiency are both slightly lower at the high end of the UHF band a variation in maximum power output occurs. The resultant transmitter rating is shown in Fig. 9.

In arriving at the power output rating of the TTU-12A full attention was given

to the technical considerations which are necessary to monochrome and color transmission. These include video frequency response, incremental gain and phase vs. amplitude distortion.²

Several photographs of typical TTU-12A performance are shown on Figs. 10, 11 and 12. These photographs which display the remarkably good linearity characteristic were taken with an RCA TA-7A stabilizing amplifier in the video input circuit.³

Fig. 10 shows the composite step wave rectified output of the TTU-12A. By pre-distortion of the step wave test signal ahead of the TTU-1B driver, the output is made nearly free of distortion compared to the test signal source. Separate details of this linearity characteristic are evident in Figs. 11 and 12. High frequency incremental gain is seen to be essentially constant in Fig. 11. A high pass filter has been applied to the composite output, Fig. 10, in making this photograph.

Fig. 12 shows the low frequency incremental gain which is equivalent to the familiar linearity test on earlier black and white TV transmitters. This photograph was made with a low pass filter applied to the output, Fig. 10.

Overall video frequency response of the TTU-1B driver and 12-KW power amplifier is shown in Fig. 13. Uniform response is obtained out to the highest color side-band frequency.

Conclusion

The TTU-12A transmitter represents the successful application of well known techniques to the difficult problem of High Power UHF TV transmitter design.

The equipment meets an important need of the industry, being economical to operate, simple to adjust and reliable in its operation. No effort was spared in bringing to the broadcaster an equipment which is the very best possible at this stage of the art.

Acknowledgment

A large team of engineers under the supervision of T. J. Boerner and J. C. Walter conducted the development and design work leading to this transmitter. Due to the complexity of the project and the large number of people who contributed, the deserved individual recognition is considered impractical.

²"Television Transmission Operation with Color Signals," by T. M. Gluyas and N. J. Oman, BROADCAST NEWS, Vol. No. 77, Jan.-Feb., 1954.

³"Video Amplifiers in Color Signal Transmission," by A. H. Lind, BROADCAST NEWS, Vol. No. 77, Jan.-Feb., 1954.

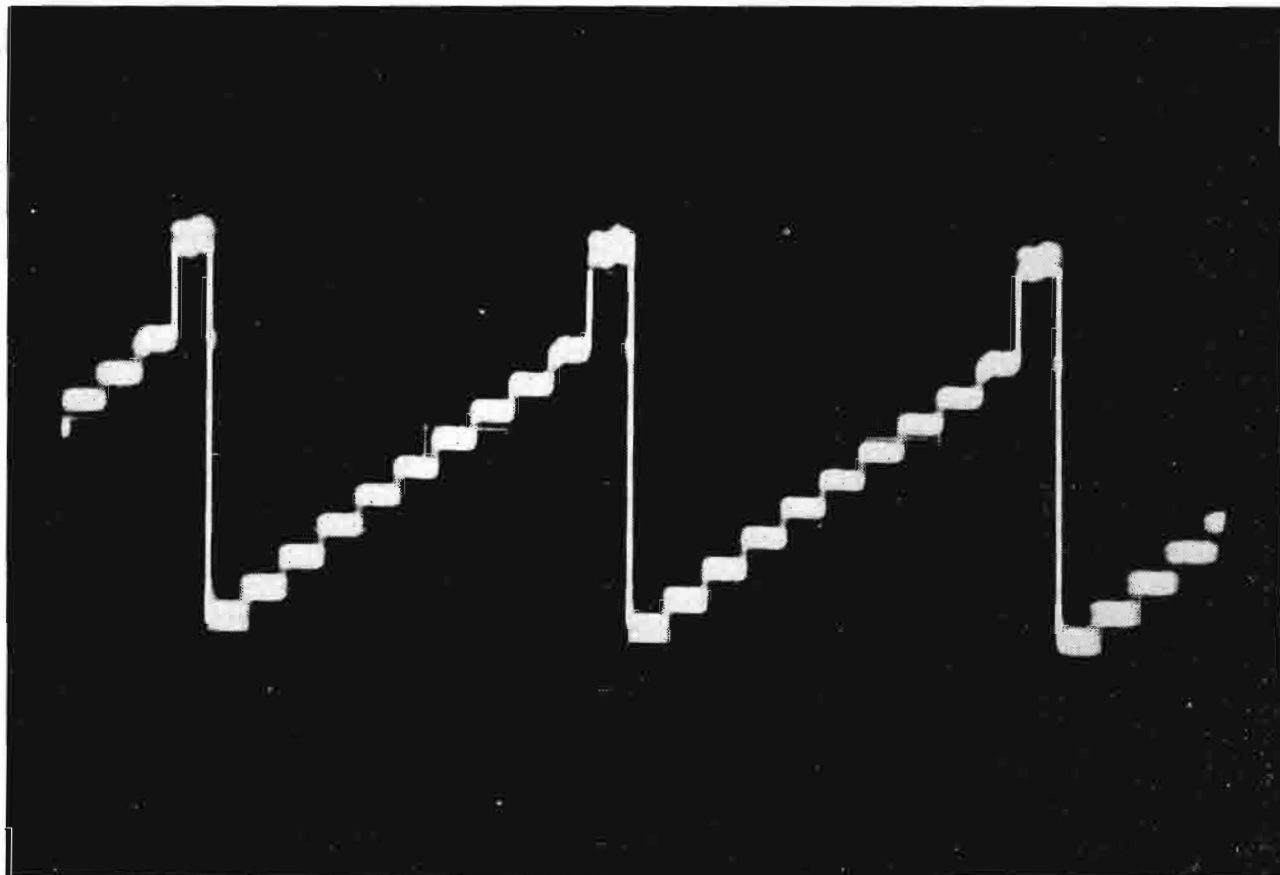

FIG. 12. TTU-12A output low-frequency incremental gain, channel 59, 11.3 KW output.

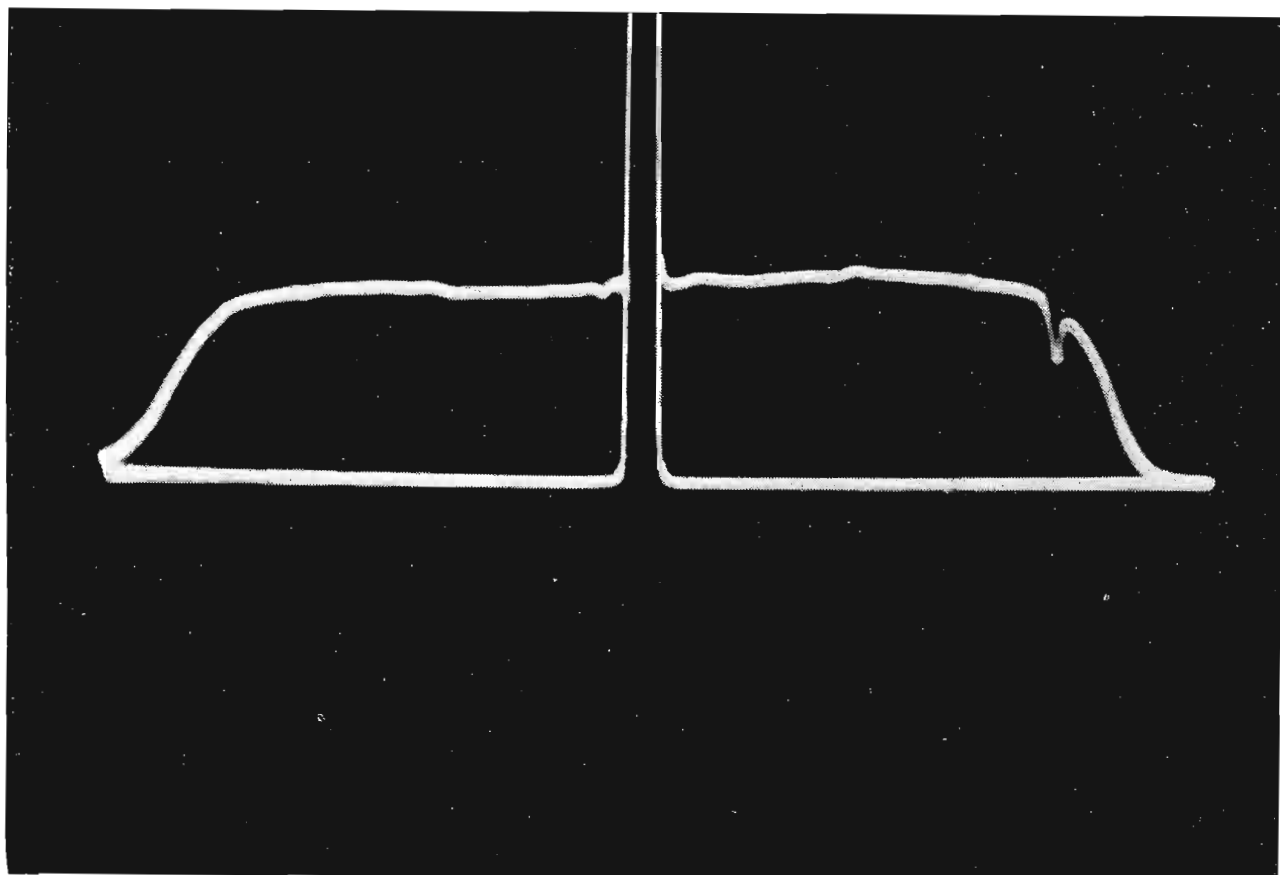
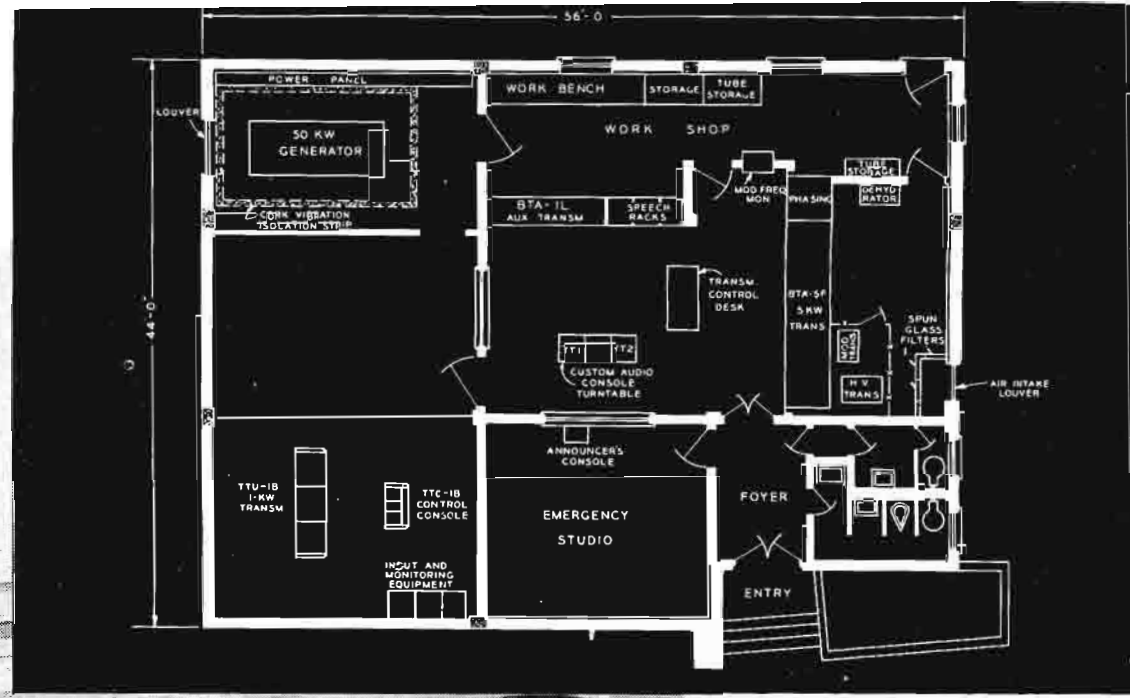
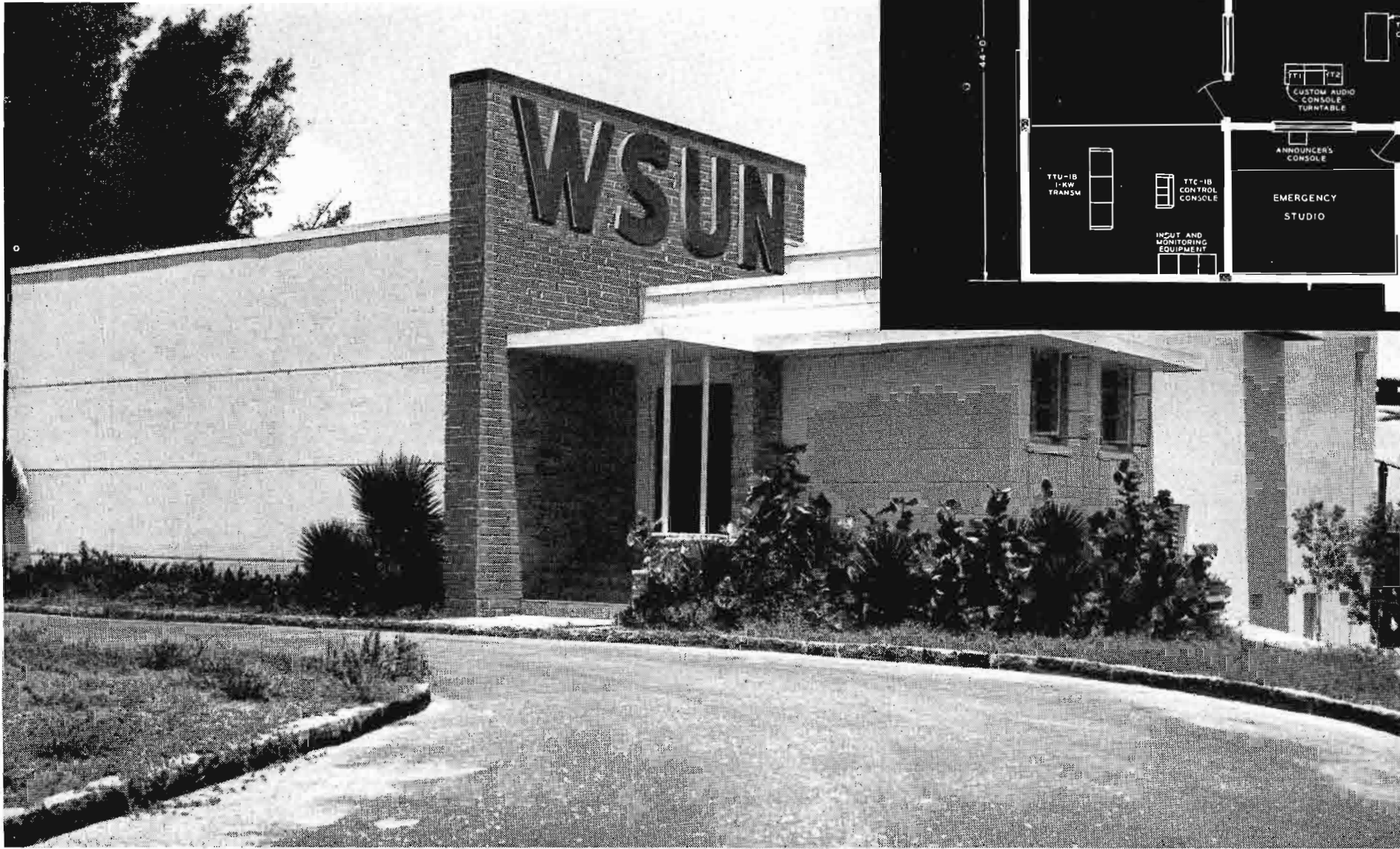

FIG. 13. The TTU-12A output video frequency response. Marker at 4.2 mc channel 44, mid-characteristic operation.

FIG. 1. Transmitter building of WSUN AM-TV, St. Petersburg, Florida. WSUN boasts an enviable record in both AM and TV. As shown in the floor plan WSUN operates an RCA 5 KW AM and an RCA 1 KW UHF TV transmitter "under one roof" with excellent performance. This is fully described in the text.



WSUN INTRODUCES TV TO FLORIDA WEST COAST

At six minutes to midnight, May 15, 1953, West Coast Floridians were, for the first time seeing the successful debut of Ultra High Frequency Television in a terrain never before utilized under such prac-

FIG. 2. Chief Engineer, Louis J. Link, WSUN AM-TV.

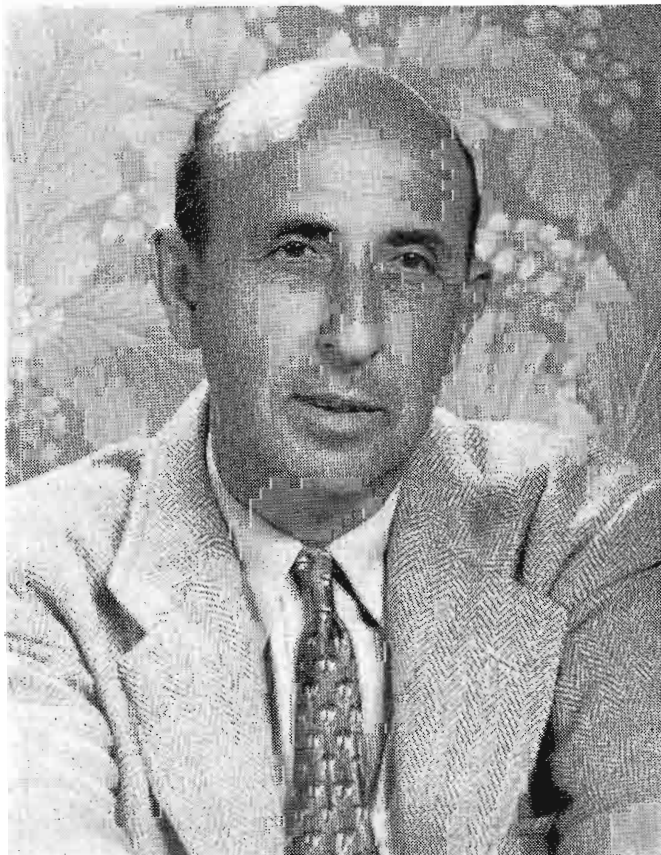

By **LOUIS J. LINK**
Chief Engineer, WSUN-TV & AM
St. Petersburg, Florida

tical working conditions. In fact this was the first television to be viewed on the Florida West Coast. The successful pioneering efforts of UHF in Florida should contribute considerably to the future of this medium in the TV industry.

This report of the city-owned station, managed by George D. Robinson, will cover, to the best efforts, the story of how facilities of Radio Station WSUN were expanded to incorporate television.

There can be no doubt of its success, for its acceptance has gone far beyond expectations, as indicated by audience response. Mail records reveal reception from a distance of 69 airmiles from the transmitter, which is located midway between St. Petersburg and Tampa, on the west approach to Gandy Bridge which links the two major cities on the Florida West Coast.

In this regard, it might be well to point out here that, according to FCC propagation curves, it was anticipated that the outer limits of the Class "B" service would extend to a distance of only 35 miles.

Pre-TV Planning

In planning the original installation of WSUN-AM (description of which appeared in the July 1952 issue of BROADCAST NEWS) much thought was given to

FIG. 3. Major George D. Robinson, Manager, WSUN AM-TV.



future installation of the TV transmitter in the same AM building (see Fig. 1). Also during the original planning of the WSUN-AM transmitter, the installation of a TV antenna atop the tower adjacent to the transmitter building, which also served as one element of a directional AM antenna system, was considered.

This particular tower was originally designed to support an RCA VHF Supergain TV antenna, since the City of St. Petersburg had made application for VHF Channel 7. Following subsequent lifting of the freeze, WSUN decided to file for UHF Channel 38 for which, in time, a construction permit was granted.

Designed to support the Supergain antenna, the tower proved very satisfactory for supporting the RCA TFU-24BM UHF antenna. Since the sub-structure for the Supergain was already in place, it was necessary only to remove a 40-foot section of this 60-foot sub-structure and replace it with the UHF antenna.

Space limitations at the top of the tower necessitated the use of $3\frac{1}{8}$ -inch transmission line the first 20 feet below the UHF antenna. This was followed by $6\frac{1}{8}$ -inch line extending to within 12 feet of the Filterplexer within the building. The balance of the line between the reducing transformer and the Filterplexer within the building is $3\frac{1}{8}$ -inch coax. See Figs. 5 and 6.

After the installation was completed, and the VSWR was measured, it was found to be well within requirements. This was due, in no small part, to care that was exercised in installation of the antenna and the $6\frac{1}{8}$ -inch transmission line.

Space was provided to accommodate a 10 kw TV transmitter. At present, an RCA TTU-1B UHF transmitter is installed and operating. See Fig. 4. Partitions were so laid out as to accommodate the additional cubicles required for the 10 kw amplifiers.

FIG. 4. View of RCA 1 KW UHF Transmitter with RCA TTC-1B Transmitter Control Console in foreground. The TTC-1B provides centralized control of transmitter, visual and aural program circuits.

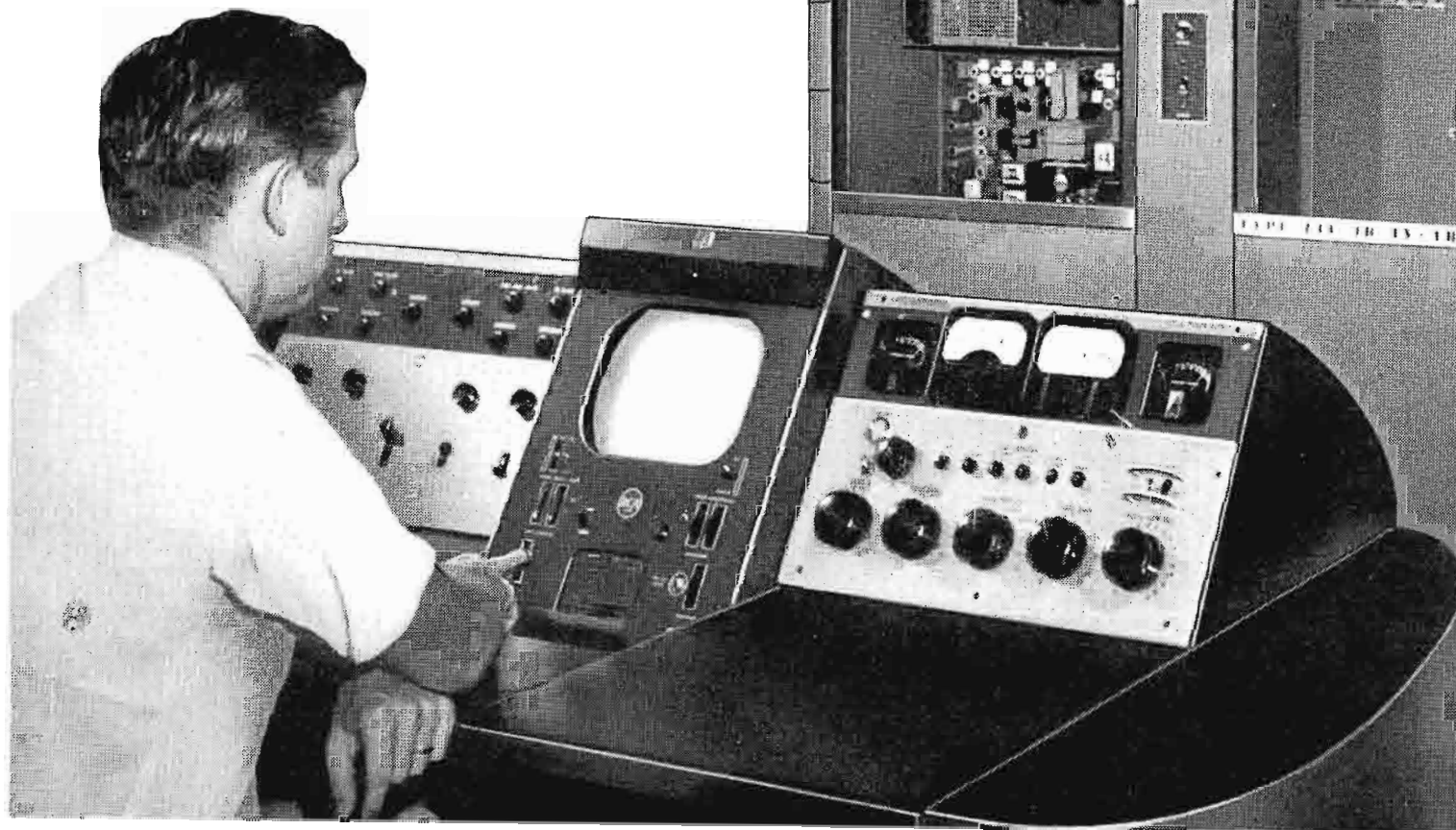

AM and TV Under One Roof

In this particular installation, the Filterplexer was mounted in a loft directly above, and to the front of the transmitter.

It will be noted from the drawing of Fig. 1 that the 5 kw RCA BTA-5F AM transmitter is located in the same building as the UHF transmitter, separated by a distance of 30 feet.

WSUN-TV remained on test pattern from May 15 to May 31, 1953 when programming on a regular basis began. Despite proximity of the two transmitters, no reaction or interference of any kind has been observed.

When the transmitter building was constructed for AM, shielding and grounding was carried out in detail. The building itself is virtually a shielded box, tied to the station ground. Before the concrete floor was poured, all the reinforcing rods were welded together. On the walls and ceiling, the metal lath was welded together, and this same principle was carried through to the individual rooms housing the two transmitters. In addition to this type of bonding, a fine mesh copper screen was nailed to the walls and ceiling of both rooms, over the rough plaster, and this in turn was bonded together by means of soldering. Acoustic tile was then applied. Copper strips were run from the screen up to the ceiling into the attic, and bonded to a 4-inch copper strap, which in turn was run to the station ground. The ceiling was

then finished in acoustic tile, and the walls with ordinary plaster.

The 18 x 18-foot emergency studio, which was originally incorporated in the building for radio, has been triple-shielded so that TV cameras can be used within this room.

Construction Precautions and Safeguards Pay Off

Before construction began on May 9, field representatives for RCA Service Company, Inc., who supervised transmission line and antenna installation, pointed out that it would be well to inspect the transmission line for even the most minute dent and that all such dents be removed from each section before it was set in place. It was decided that every possible care should be taken in the entire installation and in spite of the fact that this precaution delayed WSUN-TV ten days, every piece of the line was inspected and cleared of even the smallest dent, which might have been made in uncrating and handling of these 20-foot sections of $6\frac{1}{8}$ -inch line.

End result of this care in installation has paid off many times over in the fine picture being received on the West Coast of Florida over Channel 38. Views of the tower installation are shown in Figs. 7 and 8.

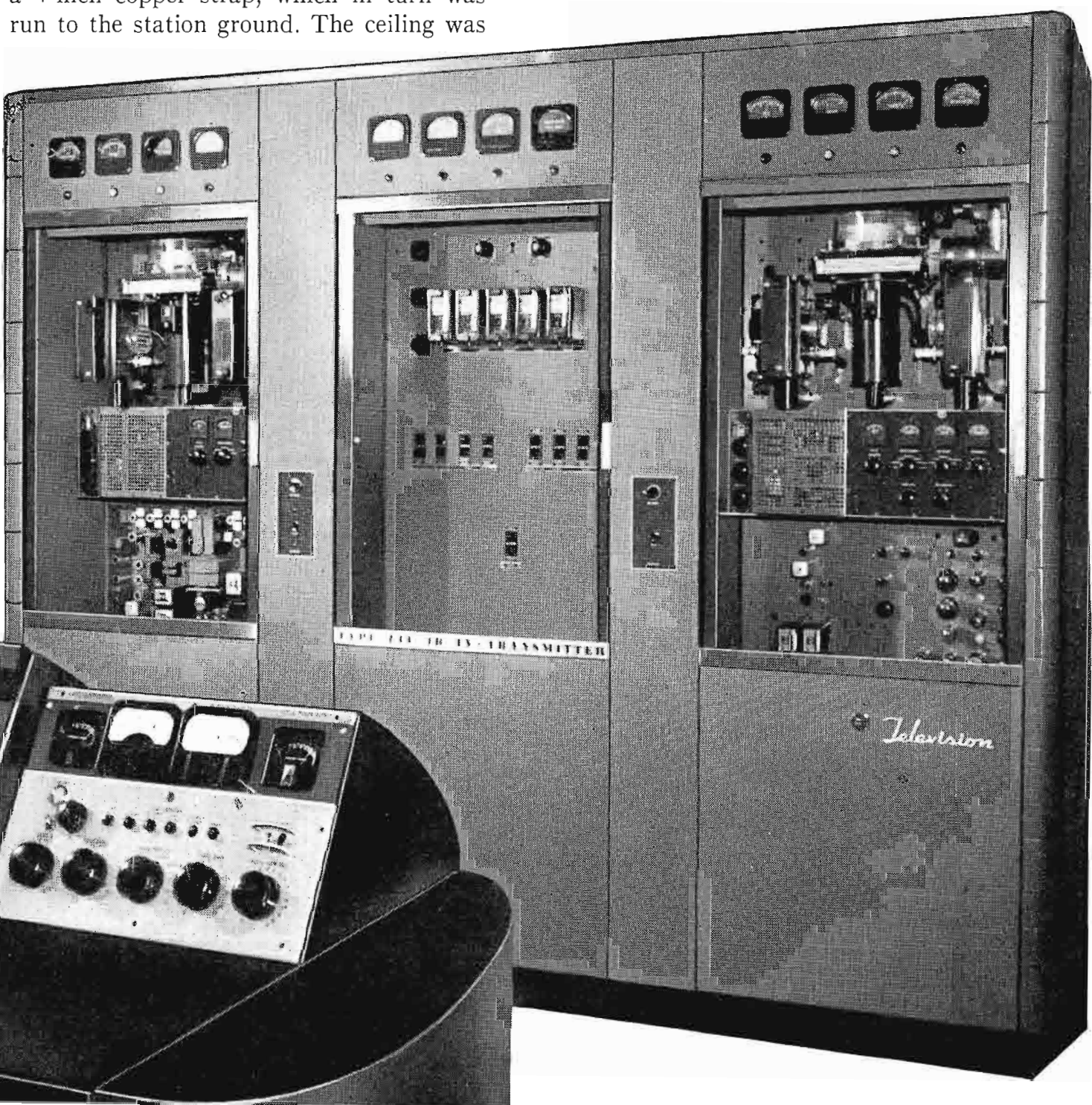

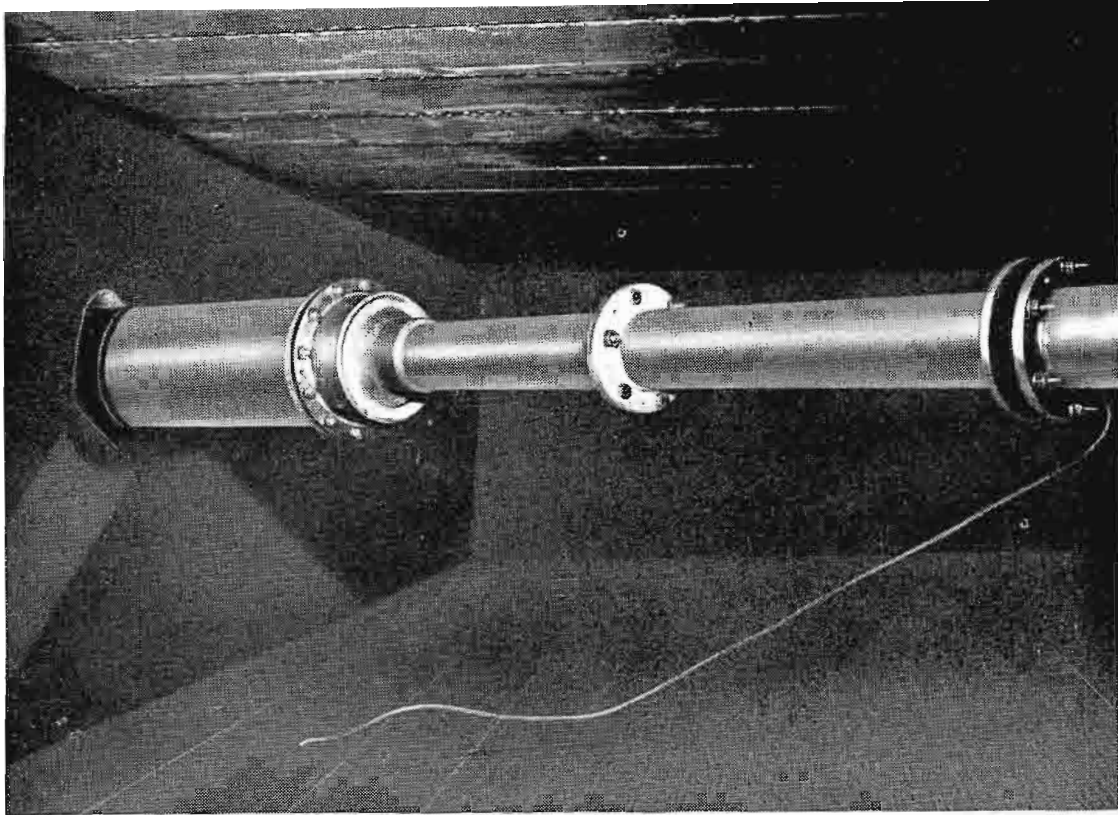

FIG. 5. This photo and the one for Fig. 6 was taken in the "loft" above the transmitter room. It shows the 3 1/8" UHF transmission line from the Filterplexer merging with a 6 1/8" line leading to the tower. The 3 1/8" 50 ohm line is efficiently matched to the 6 1/8" 75 ohm line by a reducer transformer (MI-19387-4). The 1/4" copper tubing coming through floor delivers dry-nitrogen to pressurize line to the antenna.

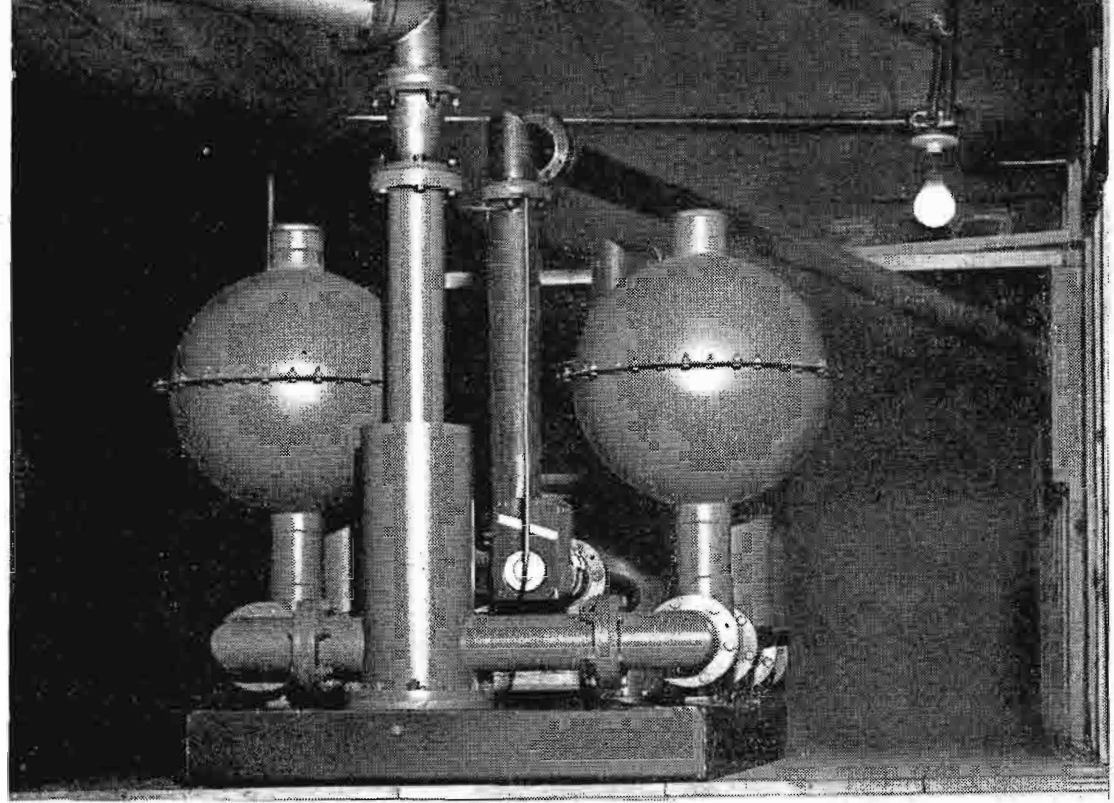

FIG. 6. The Filterplexer is located in a section of the loft above the transmitter. This permits a saving of space on the transmitter room floor and still provides facility for maintenance and insertion of an RF load and watt meter for transmitter checks. The line at upper left proceeds to the 6 1/8" reducer transformer in the adjacent photo.

20,400 Watts of ERP to Approximately a Quarter-Million Watts

With the 1 kw UHF transmitter, and with a gain of 24 in the antenna WSUN-TV has an Effective Radiated Power of 20,400 watts. Upon delivery of the 12.5 kw transmitter ERP will be increased to approximately a quarter-million watts. The antenna center point of radiation is 470 feet above average terrain. An electrical tilt of 0.5 degrees was incorporated in the antenna thus assuring a good solid signal within the Grade "A" service area.

Main Studio Facilities

WSUN's radio and television studio is located 6 1/2 miles from the transmitter on the Municipal Pier in St. Petersburg. See Figs. 9, 10 and 11. The Peninsular Telephone Company of Tampa supplies the microwave relay link which carries both the video and sound from studio to transmitter as well as the microwave between Tampa and St. Petersburg.

With the studio located on the end of the Municipal Pier, about 3/4 mile out in Tampa Bay, and with the microwave equipment located on the roof, at an elevation of 40 feet above sea level, the microwave path between studio and transmitter is across 60% water and 40% land.

There were several reasons for selection of the site of the city's new television studios:

Main studios are located just a few blocks from the business district of St. Petersburg. Original radio facilities were on the second floor of the Municipal Pier Casino. Beneath these facilities was an area 70 x 60 feet which at one time acted as a terminus for a trolley line. This space had not been used in years, hence the conversion to TV studio use. This offered a ground-floor entrance for the new televi-

sion facilities. Eight-foot garage doors open onto the main floor of the studio from the pier approach.

The studio measures 35 x 46 feet with a 15 1/2-foot ceiling. See Figs. 10 and 13. The original pier floor has been isolated by a 1-inch layer of Celotex coated with asphalt, over which a 4-inch concrete slab has been poured, to eliminate transmission

of sound through the concrete from outside traffic. This same Celotex isolation is used around all of the walls. Floors are chemically sealed to prevent concrete dust.

The studio ceiling is treated with 1-inch fibreglass acoustic tile mounted on and separated from the ceiling by 1 x 3-inch Celotex strips. Walls are treated with Air-core, a 2-inch fibreglass material covered

FIG. 7. View showing 6 1/8" transmission line leaving transmitter building and method of supporting horizontal run to the tower.

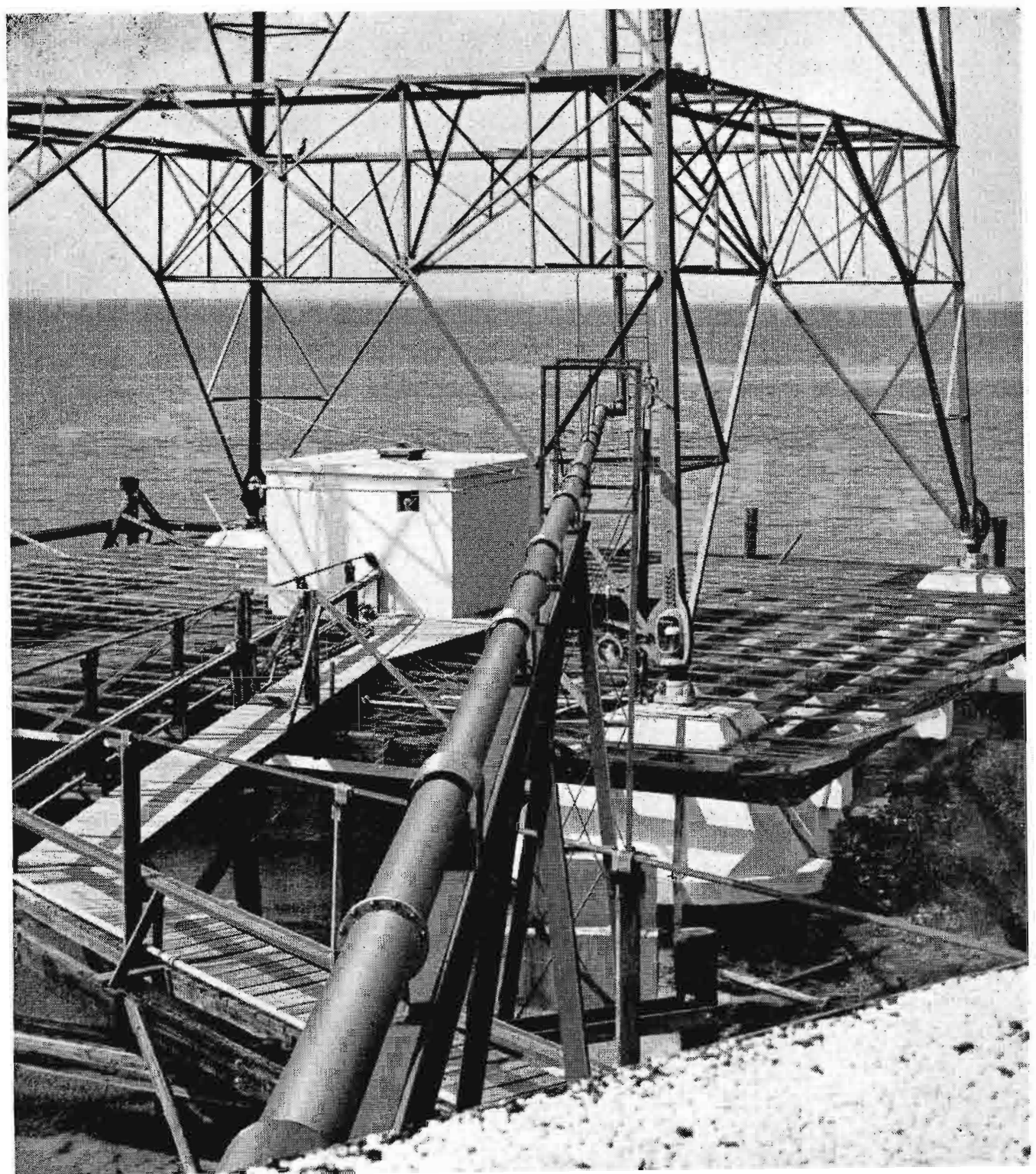

on the studio side with fibreglass gray muslin.

Above the TV operation is located the main radio studio for WSUN. In planning the TV installation, provisions were made to use this radio studio, which is 25 x 30 feet with a 14-foot ceiling. Necessary ducts for TV wiring, camera cables, were installed. Sufficient lighting load to convert from radio to TV is also provided.

With WSUN-AM and WSUN-TV located in a portion of the Casino at the end of the Municipal Pier, there is also available in addition to the space mentioned above, a ballroom having seating capacity of approximately 2000. The ballroom is equipped with a 38-foot stage. Future planning for WSUN-TV includes use of this ballroom and stage for such occasions as programming might require. Planning is such that recreational use of the ballroom would coincide with TV programming as the occasion demands.

Studio Control

The control room, raised 42 inches above the TV studio floor, is located on the north side, and with the announce booth measures 33 feet in length. It will be noted by the studio layout of Figs. 10 and 12 that the control room might seem limited in depth. This was deliberately designed this way to accomplish two things: (1) it made the video equipment racks readily accessible and (2) it provides required amount of space for working personnel *only*.

As one faces the TV studio, the announce booth is to the right of the control room, and the projection room to the left. Power supplies, stabilizing and distribution amplifiers, sync generators—12 racks in all—are placed in two rows back of the control room, along with the workshop.

The director's box is dead center in the control room, raised 20 inches from the floor, and accommodates one person with mike, and inter-com system to projection room, cameramen, mike boom operator and floor director.

Immediately before the director booth, from left to right are:

The RCA TK-3A slide camera, used in connection with special effects, eight video monitoring positions, which include controls for two RCA TK-11A studio cameras, two RCA TK-20D film cameras, a TS-10A video program switcher, two control panels for two 16mm film projectors, two slide projectors, controls for video amplifiers, and the preview monitor. This monitor can be switched to various points in the circuit, such as network, special effects amplifier, to preview picture quality.

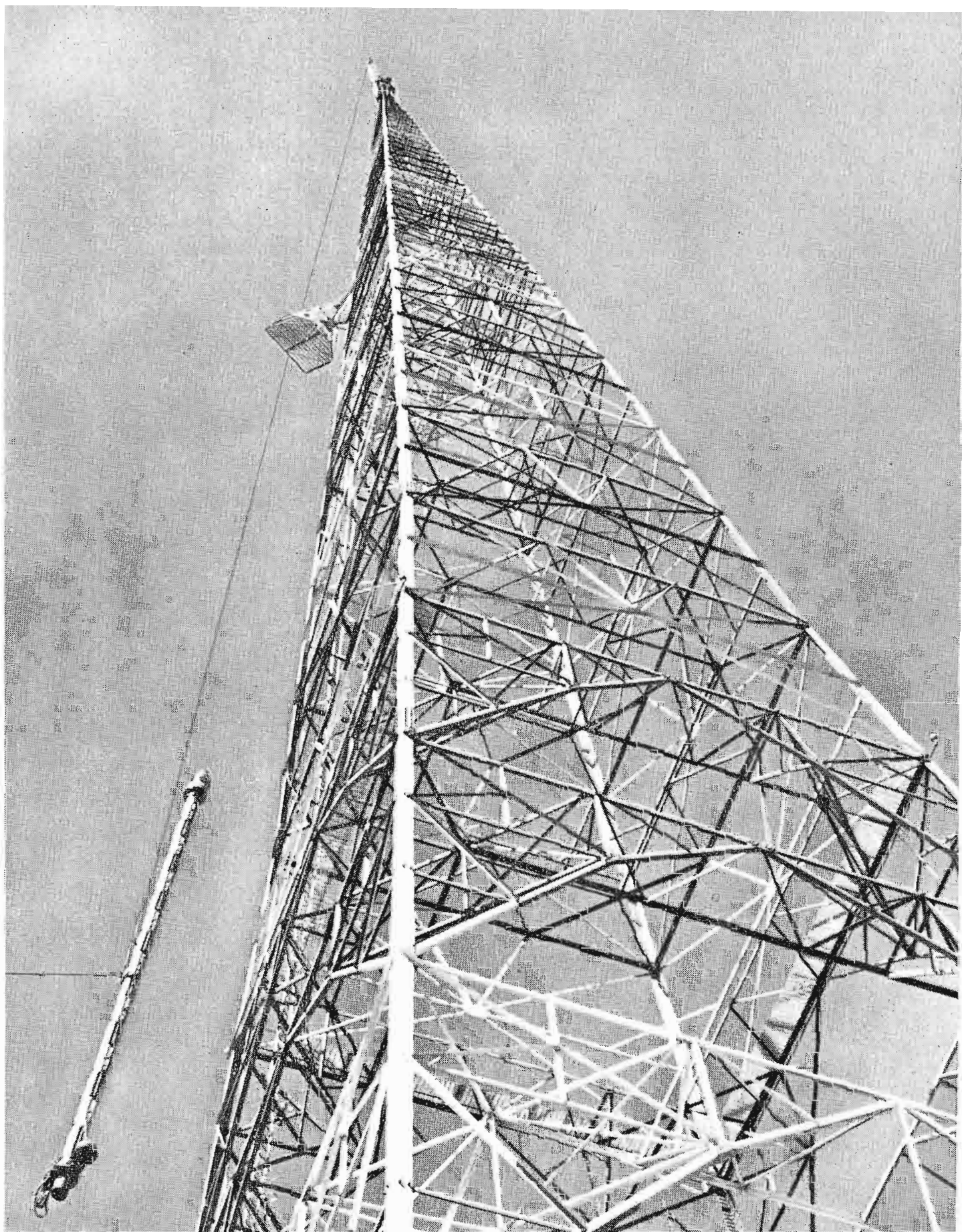

FIG. 8. Hoisting the RCA UHF Pylon Antenna is a relatively simple task. Approximately one ton and devoid of external appendages, it is easily lifted by strategically-placed shackles which provide perfect balance and control during erection.

Circuitwise, the video installation at WSUN-TV is conventional and with the TS-10A and TC-4A switchers, provision is made to bypass the TS-10A switcher allowing use of studio facilities for audition purposes. Installation includes use of two Monitrans to feed TV receivers in the building. One is normally used for regular program monitoring in departmental offices and the other for audition purposes.

Unique Switching for Audio

Audio controls and monitoring equipment are next in line. Audio portion of the TC-4A has been combined with the BC-2B RCA Consolette so that audio from network and both projectors can be controlled on either the BC-2B Consolette or the TC-4A. This is accomplished by the use of split pads in both network and projector

circuits. (See Figs. 10 and 12.) To further combine the operation, one microphone outlet in the studio was brought in to the control room on the TC-4A, which also incorporates the control for the announce booth microphone. The TC-4A then provides facilities for control of network, announce booth microphone, projector audio and one studio microphone.

The TC-4A audio and video control panel is within easy reach of the switcher, being separated by a console housing which contains the remote control panels for the three stabilizing amplifiers.

When no more than one studio microphone is needed, all audio operations can be handled by the TC-4A. However, on large studio shows, the BC-2B Consolette with the BCM-1A Mixer Consolette has



FIG. 9. WSUN AM and TV studios are located on the St. Petersburg Municipal Pier which extends $\frac{3}{4}$ of a mile out in Tampa Bay.

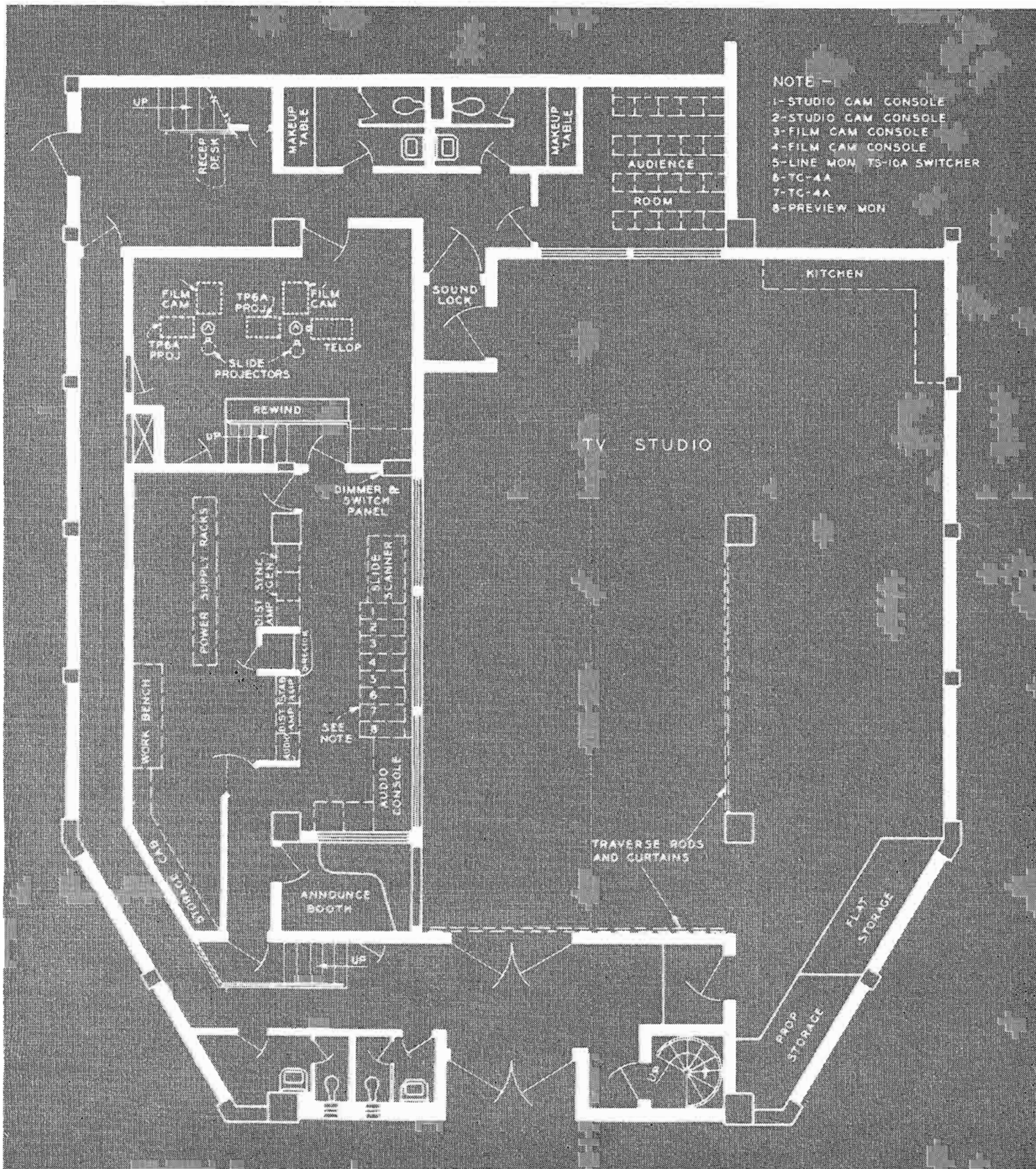

a feature which has proved extremely useful in the elimination of microphone cables on the floor. This Console has four mixers, and each mixer connects to a three-position switch, each of which feeds to a microphone wall receptacle in the studio. These 12 positions, plus the 4 on the BC-2B Console make a total of 16 microphone outlets in the studio. Microphone cables on the floor are not a problem at WSUN-TV. With radio and television facilities housed in the same building, provision is made in the audio system for simulcasts.

Next in line are the transcription turntables.

The announce booth to the right of the control room is 6 x 8 feet, equipped with a desk, on-air picture monitor, AM monitor for simulcast purposes, intercom with directors and projection room, and one microphone. Announce booth is separated from both the studio and control room by three sheets of glass—this same type of insulation is used in the program and production offices on the mezzanine, viewing windows on the ground floor, and those in continuity on the opposite mezzanine.

FIG. 10. Floor plan showing WSUN Television studio facilities on lower level of the Municipal Pier Building. Studio equipment is indicated by dotted lines. Note slide scanner adjacent to studio camera monitors.

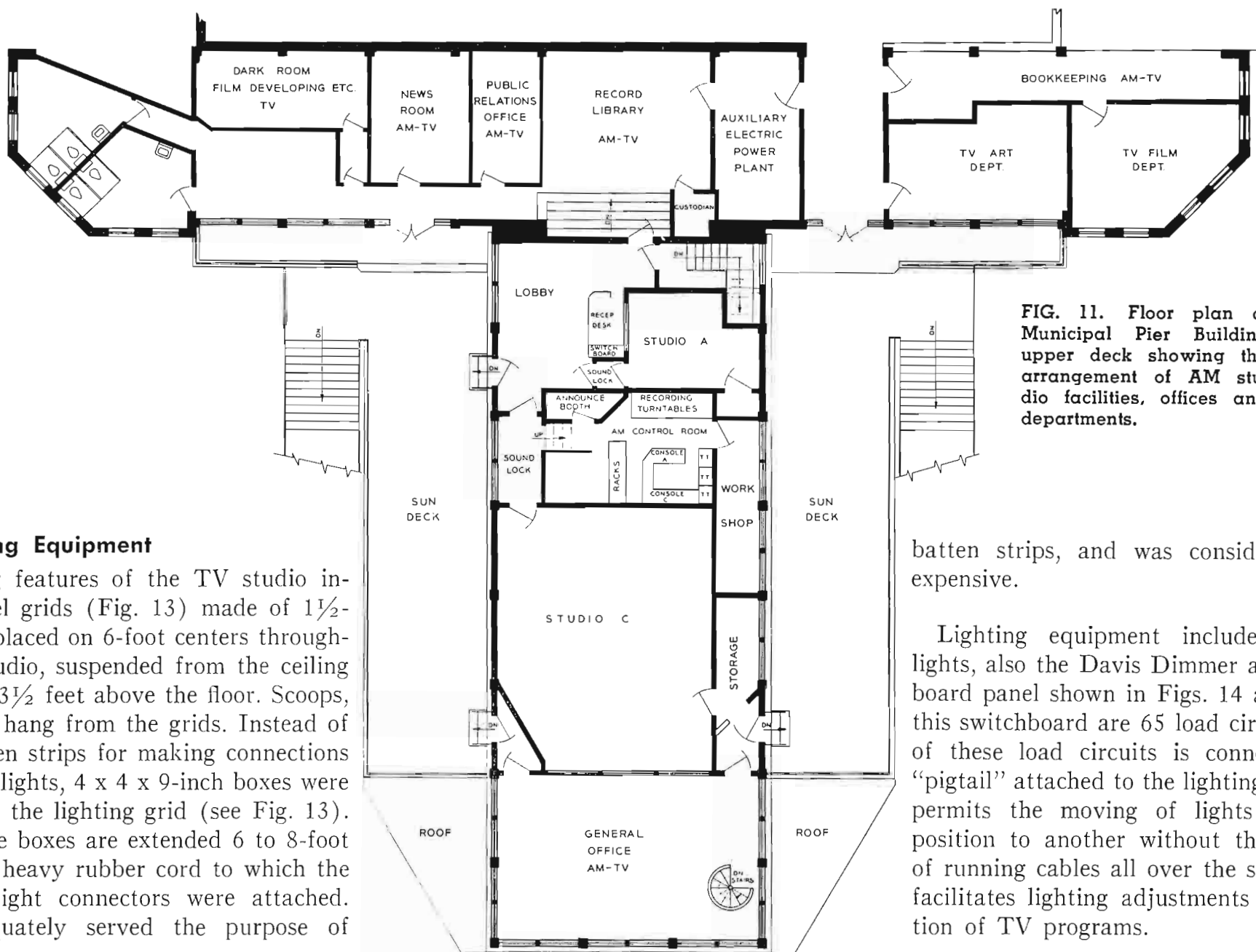

FIG. 11. Floor plan of Municipal Pier Building upper deck showing the arrangement of AM studio facilities, offices and departments.

TV Lighting Equipment

Lighting features of the TV studio includes steel grids (Fig. 13) made of $1\frac{1}{2}$ -inch pipe placed on 6-foot centers throughout the studio, suspended from the ceiling at about $13\frac{1}{2}$ feet above the floor. Scoops, spotlights, hang from the grids. Instead of using batten strips for making connections to various lights, 4 x 4 x 9-inch boxes were inserted in the lighting grid (see Fig. 13). From these boxes are extended 6 to 8-foot lengths of heavy rubber cord to which the standard light connectors were attached. This adequately served the purpose of

batten strips, and was considerably less expensive.

Lighting equipment includes Century lights, also the Davis Dimmer and Switchboard panel shown in Figs. 14 and 15. On this switchboard are 65 load circuits. Each of these load circuits is connected to a "pigtail" attached to the lighting grid. This permits the moving of lights from one position to another without the necessity of running cables all over the studio. This facilitates lighting adjustments in production of TV programs.

FIG. 12. Studio Control Room. From far end, console equipment consists of two monitors for studio cameras, two film camera monitors with control units, a line monitor with TS-10A switcher, two console housings comprising the TC-4A switchers and a preview monitor. Moving forward from the telephone and intercom unit is the BCM-1A audio mixer and the BC-2B audio consolette. An RCA utility monitor and 70-D transcription turntable are in the foreground. To the left is studio rack equipment and the director's box. In the background is the film room and the studio lighting control panel.



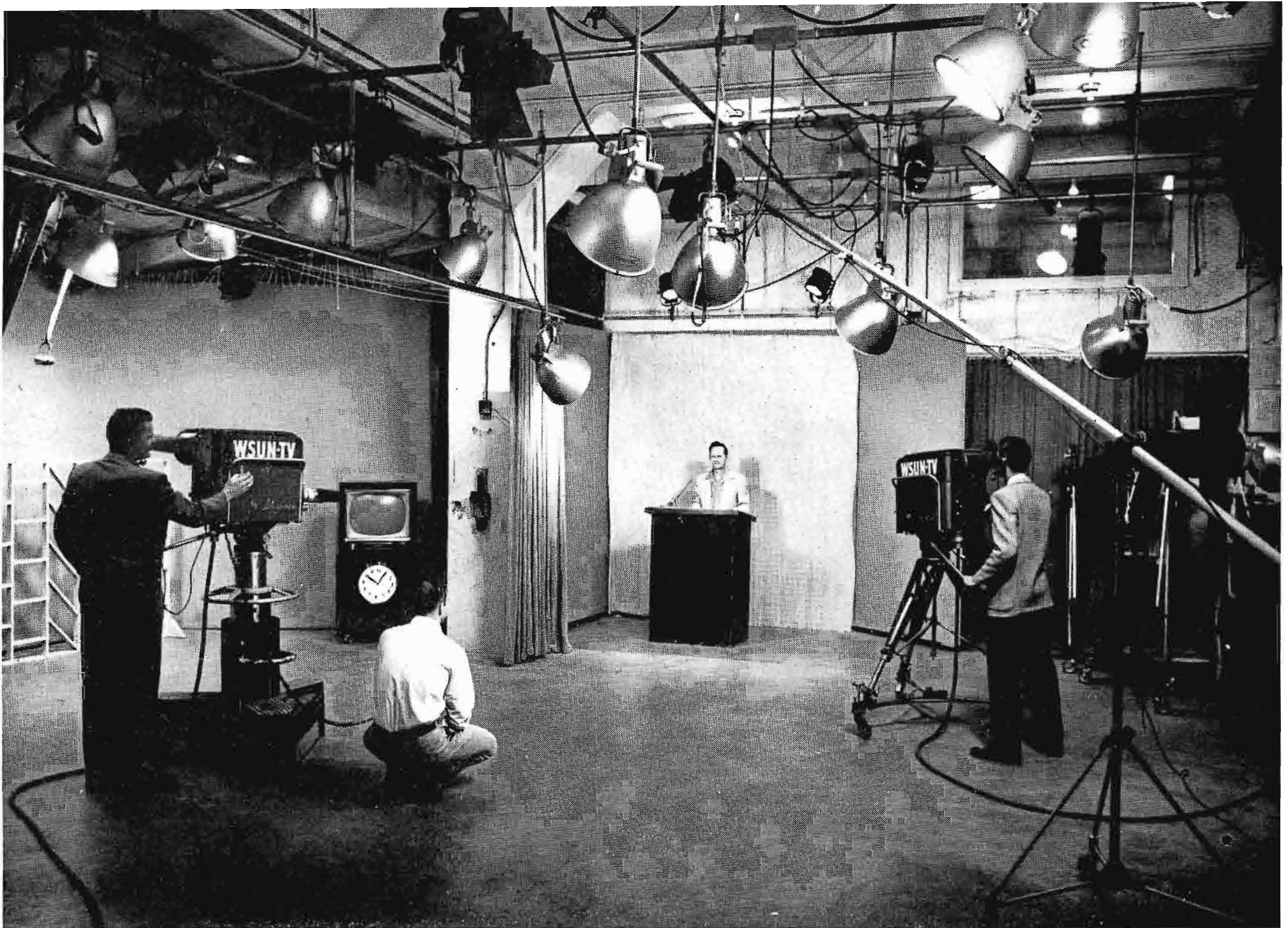

FIG. 13. A studio scene showing clean orderly arrangement of equipment. This is attributed to the convenient lighting system shown in Figs. 14 and 15 and described in the text under "TV Lighting equipment." RCA TK-11A studio cameras are shown—pedestal-mounted on left, tripod-dolly-mounted on right. Century boom holds RCA 77-D microphone.

Special hangers for each scoop were constructed locally. A sleeve was brazed to a regular fixture clamp, a 1/2-inch pipe is at-

tached to the scoop, height adjustment is made by inserting a pin in holes at various points along the pipe. These serve the pur-

pose of pantagraph hangers. While not as flexible as the scissors type, they are not as costly.

FIG. 14. Davis Dimmer and Switchboard Panel with rack of Connecting Cords for selecting studio lighting combinations.

FIG. 15. Close-up of the Davis Switchboard Panel which contains 65 color-coded load circuits—each connected to a "pigtail" attached to lighting grid.

A permanent all-electric kitchen set is installed in the southeast corner of the studio (see Fig. 10), including cupboards, sink, stove, water heater and dishwasher. Cupboards are wood constructed, and the kitchen is finished in flat-toned pale yellow paint to reduce reflective glare.

Offices and Accessory Rooms

Administrative services for both radio and TV are located on the second floor of the Pier. Mezzanine floors, located on east and west ends of the building, house continuity writers, program and film directors, production departments. The public entrance, located on the east end, leads to viewing rooms, talent dressing rooms, and stairs up to the continuity department. Both mezzanine offices have viewing windows down into the TV studio.

Film Equipment

To the left of the control room, facing the studio, is the film projection room, measuring 13 x 20 feet. Film equipment consists of RCA TP-6A film projectors, two slide projectors for 2 x 2-inch slides, two 16mm RCA TK-20A film cameras. The Gray TelOp II for 3 x 4-inch opaques

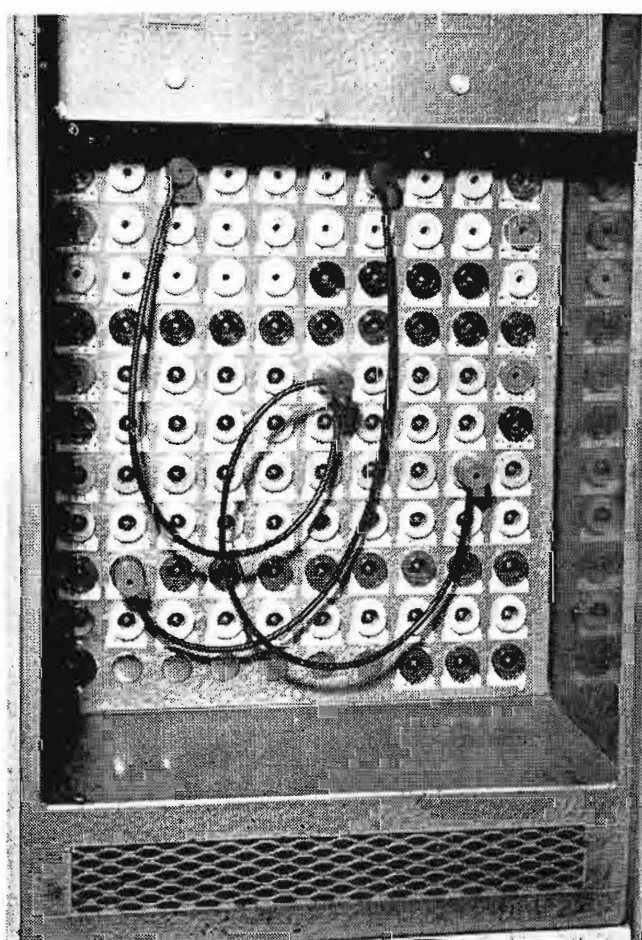

FIG. 16. Major George D. Robinson, Manager of WSUN AM-TV, interviews guests—using the RCA "Starmaker" microphone.

includes a roll stock titler, a news tape and clock. See Fig. 17.

Locating the projection room at one end of the control room has proved very satisfactory in practice. Not only is it accessible in times of trouble, but its proximity to the control room and the operating positions provides a simple method of conveying messages between personnel, which can be handled much quicker than through the use of inter-com. Editing and splicing of film is handled in a room on the same floor adjacent to the projection room.

Second floor television facilities include a complete art department, a film library, film laboratory and dark room, news rooms, commercial department and general offices.

WSUN-TV is equipped to handle any art or film demands of production department or clients. Equipment for the film department includes five 16mm movie cameras, five still cameras. The art department is equipped to build any type or size prop or flat.

Station manager, chief engineer and pub-



lic relations offices for television and radio are also located on the second floor.

WSUN-TV is a complete well-integrated

station dedicated to provide the best in programming and reception to the televiewers of West Central Florida.

FIG. 17. View of WSUN-TV film room. Two RCA TP-6A Professional Film Projectors are shown, each with an individual TK-20D Film Camera. Multiplexed with the film projectors are two automatic slide projectors, and to the right, a Gray Tel-Op. Above are three RCA Utility Monitors.





FIG. 1. A typical arrangement showing the TS-5A Video Switcher supplementing the facilities of the TC-4A Audio/Video Switching Console.

TS-5A, VERSATILE NEW SWITCHER

The use of fades, lap-dissolves, and superpositions to provide smooth transitions between scenes in a live show or between live cameras and film has become a basic programming necessity. Recognizing this, RCA has designed the TS-5A Video Switcher to offer these features in a package which may be used economically by the small station which has only a limited number of picture sources.

Expansion of TC-4A Switcher

It is designed for use either in conjunction with existing systems, or as an independent switching system. Probably it will find widest use with already installed systems where the flexibility of its electrical

By C. R. MONRO
Terminal Equipment Engineering
Engineering Products Division

and mechanical design permits neat, simplified installation. An example of this may be found in a broadcasting activity which began operations with a "Basic-Buy" layout. Video control functions are here centered around the TC-4A Audio/Video Switching Console. Subsequent plans, however, call for expansion of the original station plant to include a live-talent studio with two cameras. If program requirements are simple, the TC-4A Program Switcher

would be adequate, but it must be remembered that direct switching is the only picture transition conveniently possible. In conjunction with the stabilizing amplifier, a clip-fade may be made during transfer to or from the network or a remote, but this is not suitable for routine live program use. The program people would soon demand provisions for lap-dissolves and supers as productions became more ambitious. Fig. 1 shows the TS-5A used to expand the facilities of the TC-4A Audio Video Switching Console.

Fig. 2 illustrates, in block diagram form, the station layout just described. In addition to the inputs for network and remote, both studio cameras and the film camera

are fed to the TC-4A Program Switcher. The requirements for direct switching are thereby met.

Note now, that the TS-5A may be integrated easily to add the desired facilities for mixing and fading, complete with push-button selection of picture sources to be fed to the fader lever circuits. Its output is fed into a previously unused input to the TC-4A. This arrangement preserves the original remote and network switching, and allows for direct pick-up of any of the local cameras, which also permits preview of the TS-5A fader output before putting it on the air. Another item to illustrate the flexibility possible is the use of the TS-5A for the rehearsal of a studio show while the TC-4A is carrying network or film. In this particular diagram, the fourth input to the TS-5A is available for test pattern or station call. The fifth position would normally be used for release or "black," but may be used as a regular input if desired.

Obviously, there may be many variations within this general equipment layout. The availability of particular auxiliary equipment in either the existing station or in its plans for expansion, and the floor plans suitable for the activity required, will determine the exact plan. For example, the same block diagram, Fig. 2, could be used to illustrate a completely separate studio control console feeding the TC-4A console in the transmitter control room. Actually the exact arrangement of monitoring facilities would be the major point for discussion. The final decision would be based on a choice between location of the switcher so the operator can see the camera control monitors, provision of a switchable monitor for the operator, or the use of several separate monitors.

Expansion of TS-10A Switcher

Another block diagram which illustrates some of the same principles is shown in Fig. 3. In the station plan upon which this is based, a TS-10A Studio Switcher was in service at a studio control location. The addition of more cameras resulted in a demand for more inputs than were originally provided. The solution illustrated here employs a TS-5A Switcher for all of the studio and film camera switching required for live-talent show, and hence provides the additional inputs needed. The TS-10A is then used for network and remote switching, and, with the film cameras also fed to it, permits use of its fader for transitions between the TS-5A output and film programs. This also permits independent studio rehearsal. If, as shown here, it

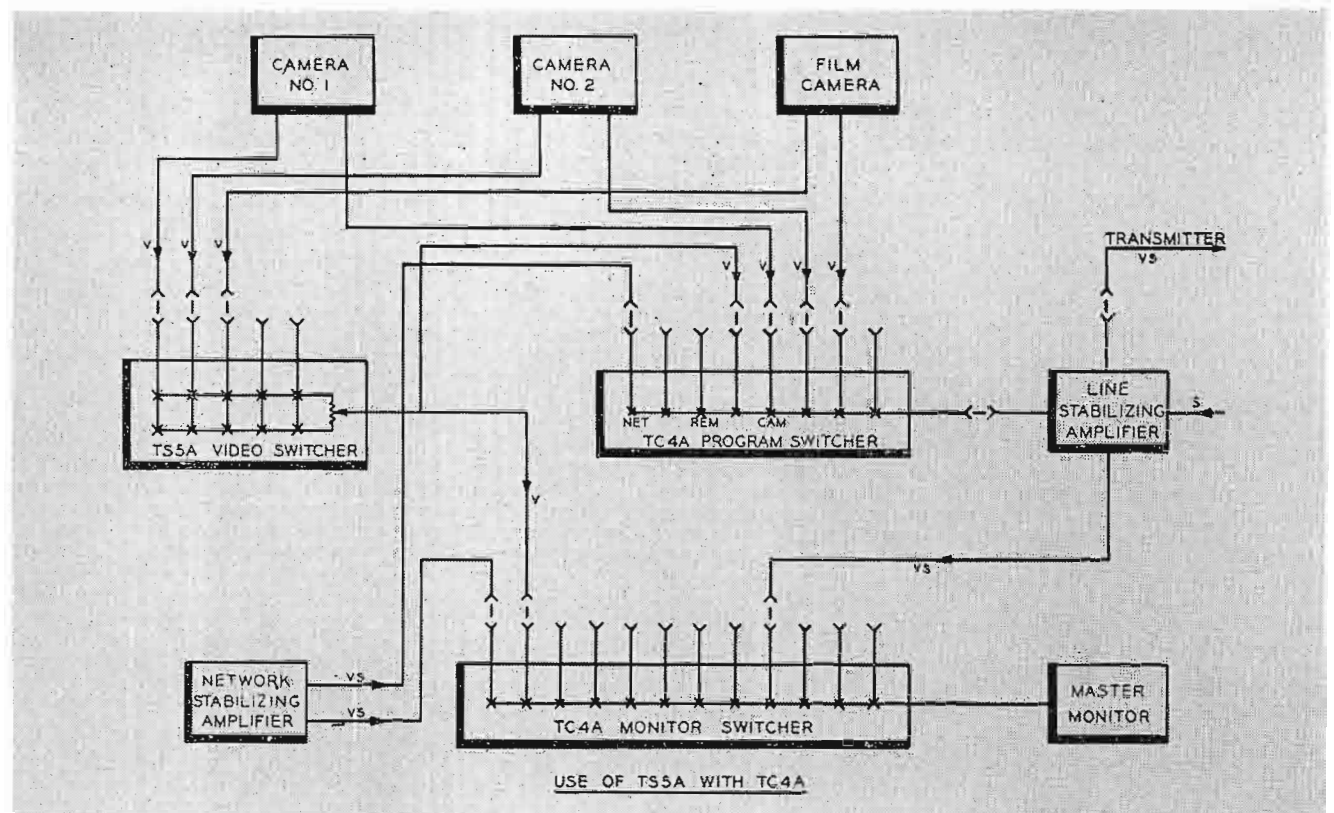

FIG. 2. The TS-5A Video Switcher is a particular advantage to small stations who wish to expand the facilities of their TC-4A Switching Consoles. Such a system is shown in block diagram above.

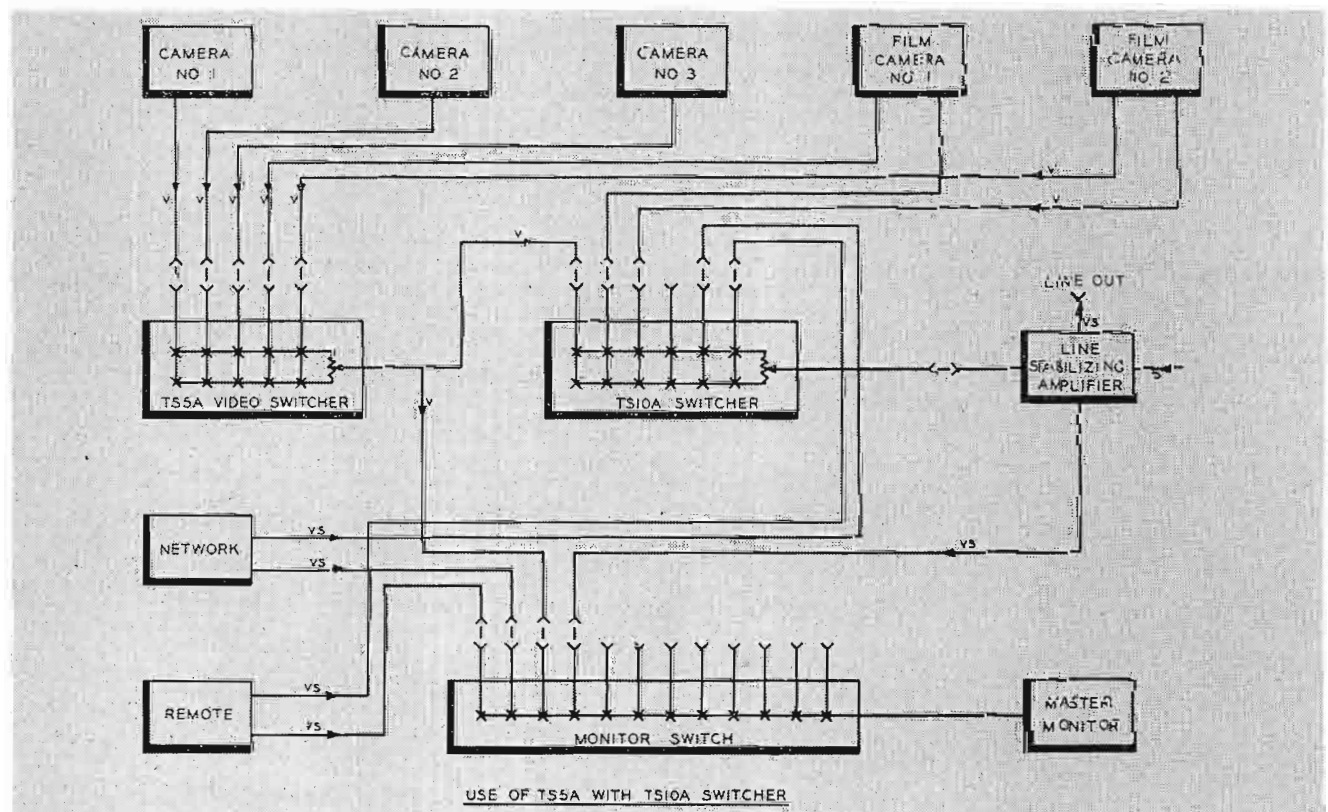

FIG. 3. Stations may also add the flexibility of the TS-5A Video Switcher to their RCA TS-10A Switching Equipment. Block diagram above shows a typical arrangement of both TS-5A and TS-10A.

is necessary to use all five of the TS-5A input circuits, it is still possible to fade down to black by releasing all the buttons in one row. A circuit, looped through all the button circuits provides for this.

Again, the problem of the relative location of monitors and the switching provided for them depends largely upon the physical arrangement of the various consoles. The video connections shown in Fig. 3 assume that the studio camera control monitors are visible to the TS-5A operator. If this

could not be done, additional cables could be run to the monitor switch.

Independent Switching Unit

Finally, Fig. 4 illustrates the use of the TS-5A as an independent switching system. This would be typical of a relatively small layout with the camera controls arranged in line with the console used for the switcher. The master monitor is used to observe the picture and waveform on the outgoing transmitter line, while the oper-

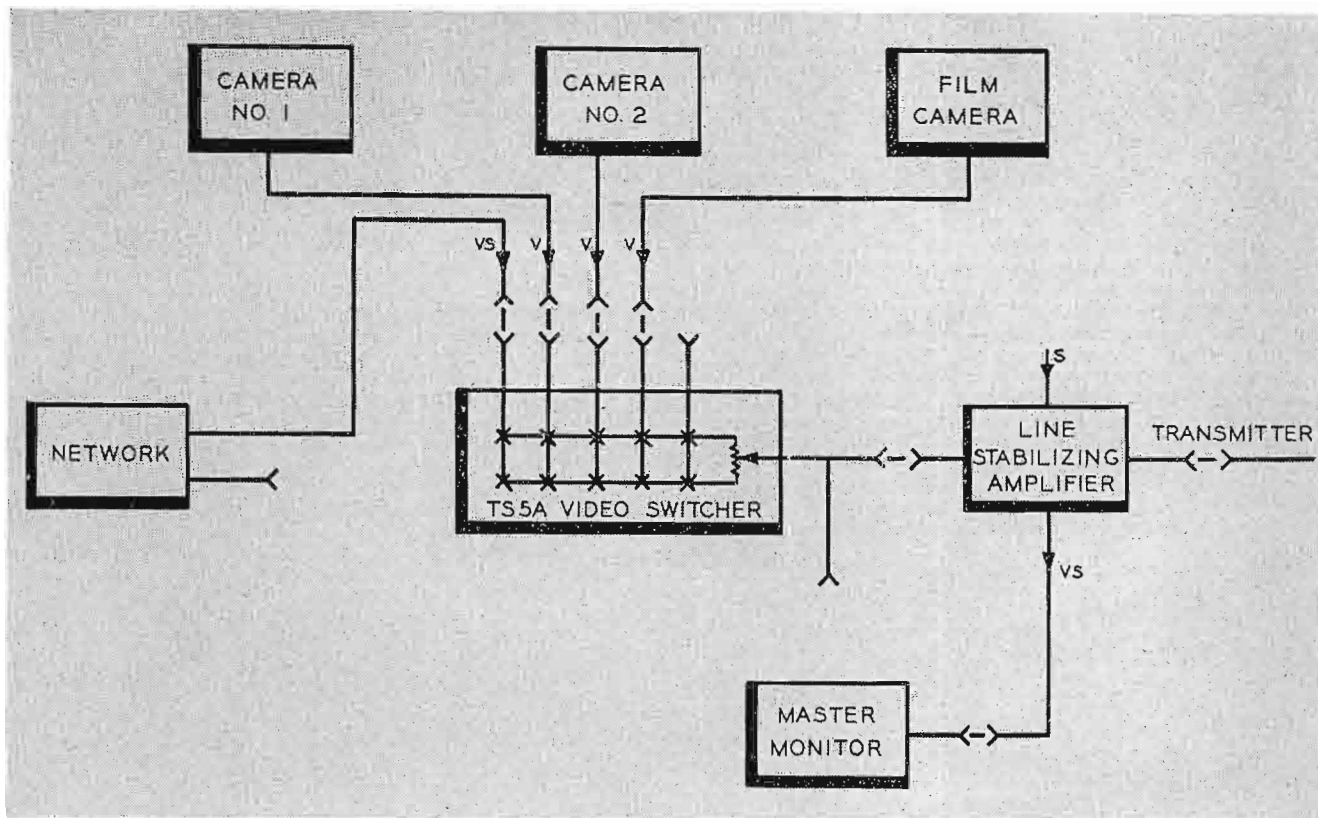

▲ FIG. 4. This block diagram shows the use of the TS-5A as an independent switcher. This is a typical relatively small layout.

▼ FIG. 5. The TS-5A may be mounted in a remote control panel basic frame where it occupies that space of two remote control panels.

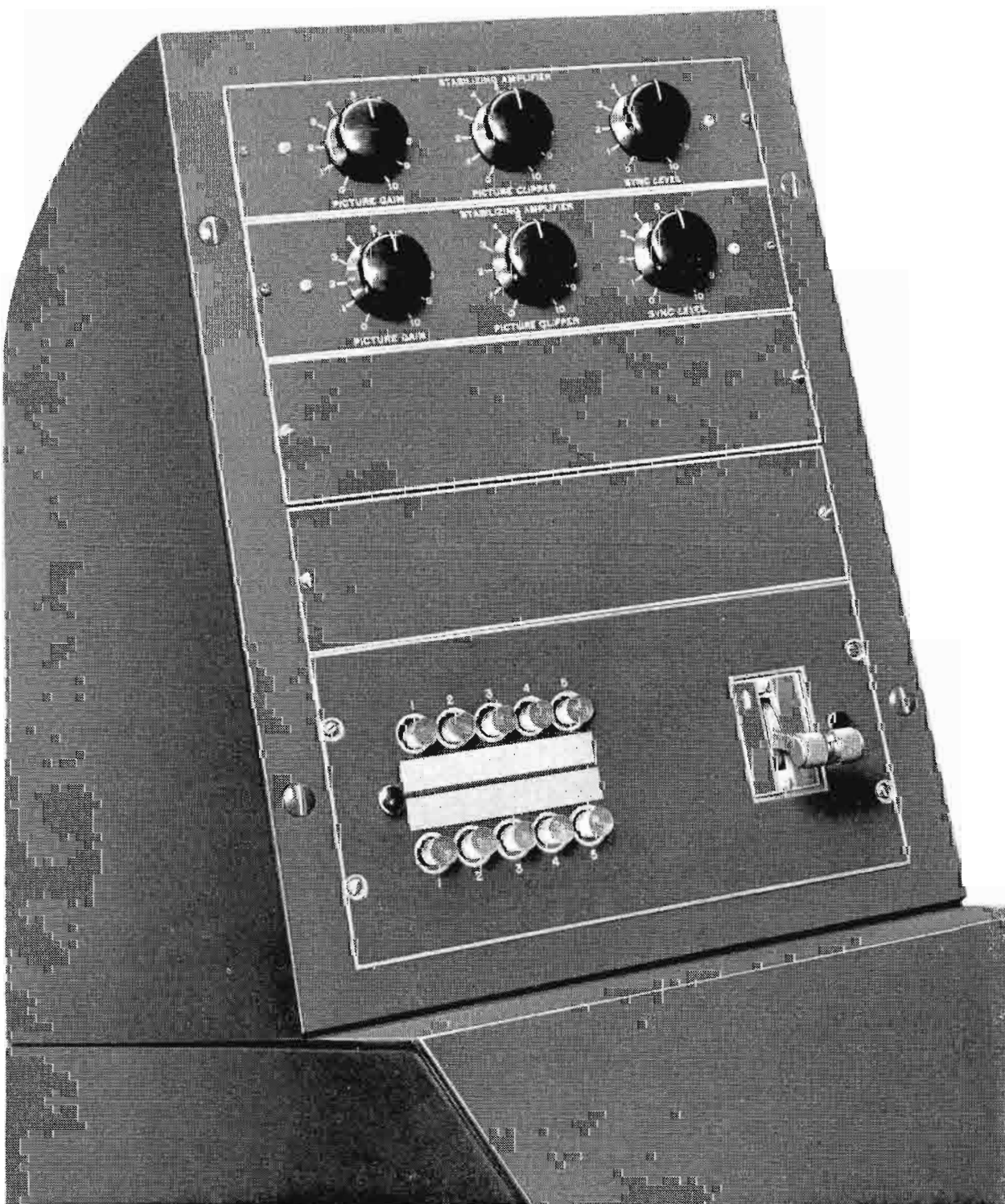

ator views the camera control monitors to observe the incoming local picture signals. The stabilizing amplifier is used here to add sync and to feed the transmitter with suitable control of picture and sync levels. It is not intended that it is essential to every application of the TS-5A. The switcher is designed to operate at standard signal levels with excellent response at both low and high video frequencies, and does not require low frequency tilt correction or bounce suppression.

Discussion, so far, of stations of a relatively small size does not mean that the TS-5A cannot find good use in the larger ones. In the same ways already mentioned, it may be employed to supplement existing facilities and to provide an economical solution to new installation problems.

Flexible Mounting Arrangements

In order to provide a flexible mounting arrangement, the TS-5A is divided into two separate units which fit into a single standard console housing. The pushbutton and fader panel may be located in a standard remote control panel basic frame as shown in Fig. 5. Here it occupies the space normally taken by two remote control panels. Fig. 6 illustrates mounting of the pushbutton panel in the sloping desk area of the control console. Hinge brackets are supplied which form the side trim strips and center the panel assembly so that it may be held firmly with thumbscrews from below. The panel then hinges down to clear the master monitor when it is removed from the console. For either of the panel locations described, the amplifier chassis remains in the lower portion of the console, where it is located on brackets provided. (See Fig. 7.) Installation of the TS-5A is simplified by the use of existing holes in the console frame for the mounting brackets. All necessary hardware is provided with each switcher. The front panel of the pushbutton chassis snaps off for access to the pilot lamps and tube. The amplifier tubes face forward on the vertically mounted chassis and are accessible behind the lower front cover of the console.

The pushbutton switch mechanism is the familiar, easy-acting mechanically interlocked type. Considerable care has been exercised, however, to make it suitable for broadcast service. Special features include solid silver alloy contacts, long wearing slider insulation material, and careful lubrication. The fader assembly, shown separately in Fig. 8, is a newly designed unit, appearing for the first time in the TS-5A. It includes several new mechanical refinements for smoother, more dependable action. The handles are metal and one is designed to

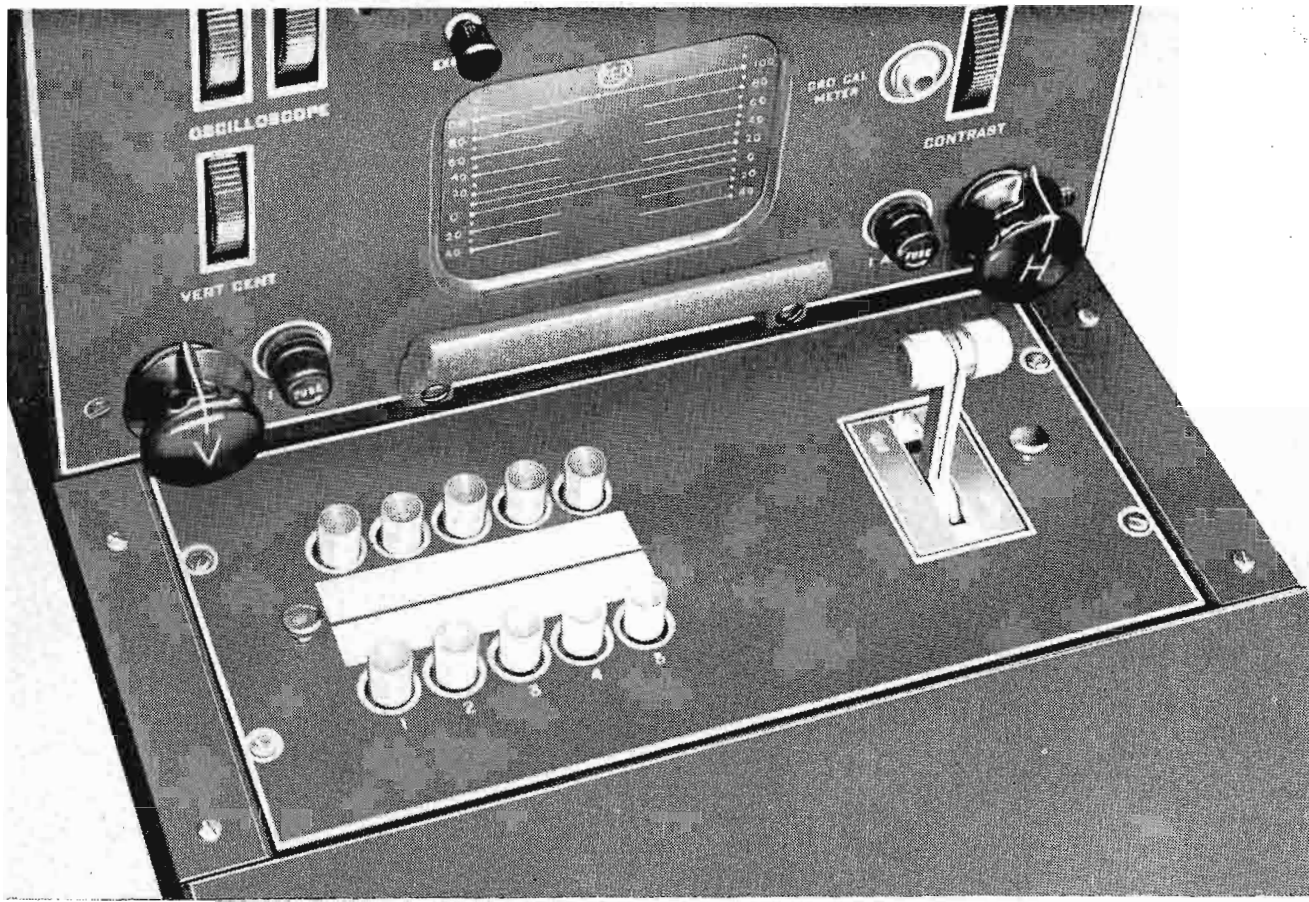
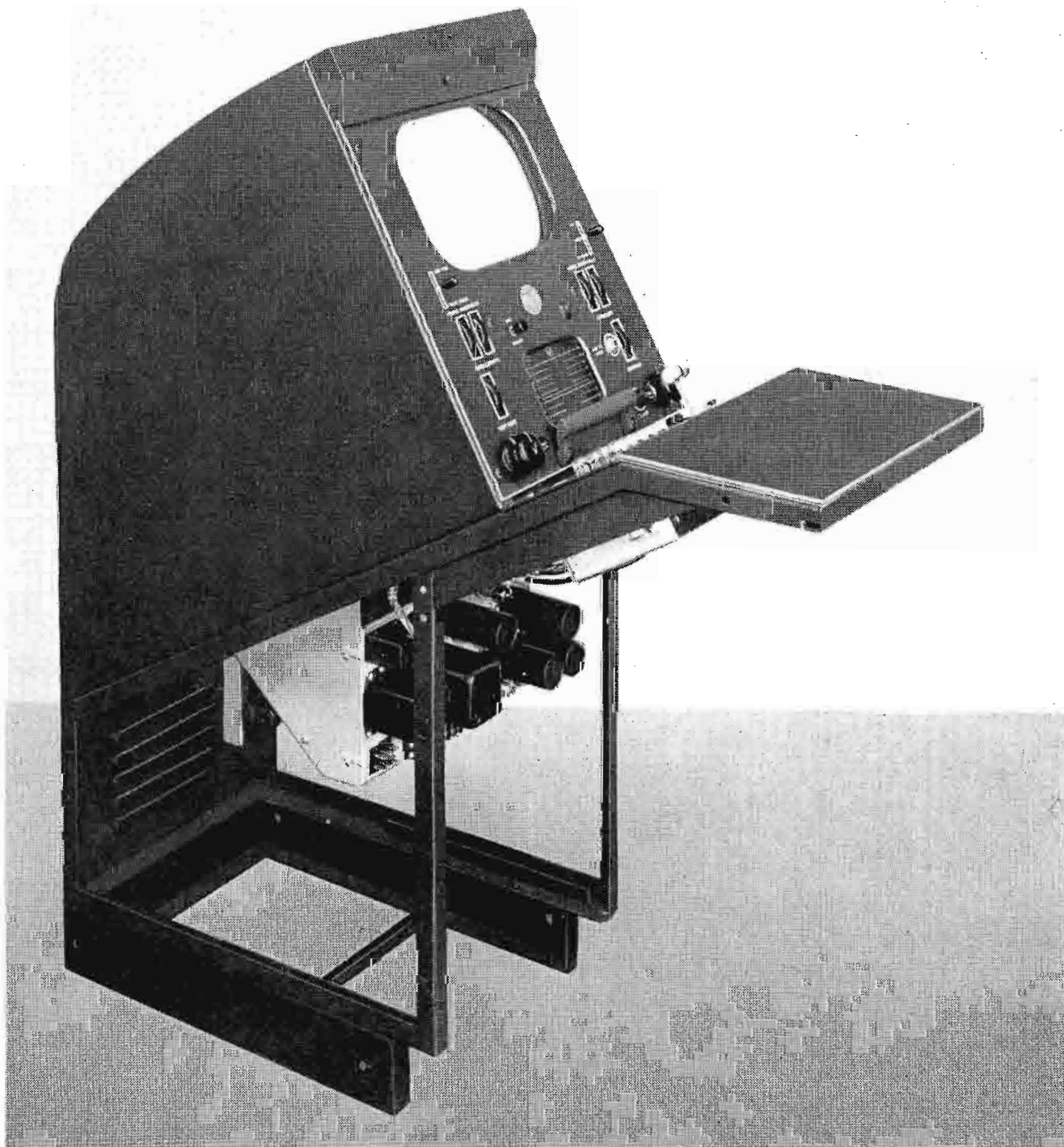

FIG. 6. The Video Switcher, TS-5A, may also be mounted in the ▲ sloping desk portion of a standard console housing as shown here.

FIG. 7. The TS-5A Switcher is shown below with its control panel and amplifier unit mounted with a TM-6B Master Monitor in a standard console housing. ▼



provide a positive, easy to operate lock for moving the two levers in unison. Rugged, yet closely adjustable mechanical stops are provided on the levers. Relay type, twin contact limit switches are used for the multiple circuits required.

The electrical circuits chosen for the TS-5A represent a blend of economy, flexibility and performance. Direct video switching is employed with a contact arrangement which permits either gap or overlap switching. The change from the overlap connection normally supplied may be made very easily by clipping jumper leads on the push-button switches. Twin cathode follower circuits isolate the inputs from the fader potentiometers. The two fader outputs then are resistance mixed and fed to the output amplifiers.

Two outputs are available for feeding a 75 ohm line at standard level. If the output line is long and requires sending end termination, the two outputs may be paralleled.

Complete tally circuit switching suitable for studio or film cameras is incorporated in the pushbutton and fader limit switch circuits. These circuits may also be used for sync interlock with appropriate control means in the sync addition amplifier. If required, as in an independent installation, sync must be added to the output signal in a distribution or stabilizing amplifier. When the output of the TS-5A is fed into another switcher and the other switcher also supplies tally circuits to one or more of the same cameras connected to the TS-5A inputs, then a tally relay is required in the TS-5A to prevent accidental false tally indications. The relay is an optional item, and is not required for independent operation of the TS-5A. The block diagrams, Fig 2 and Fig. 3, would require use of the relay while Fig. 4 would not.

FIG. 8. The fader mechanism located in the control panel of the TS-5A.

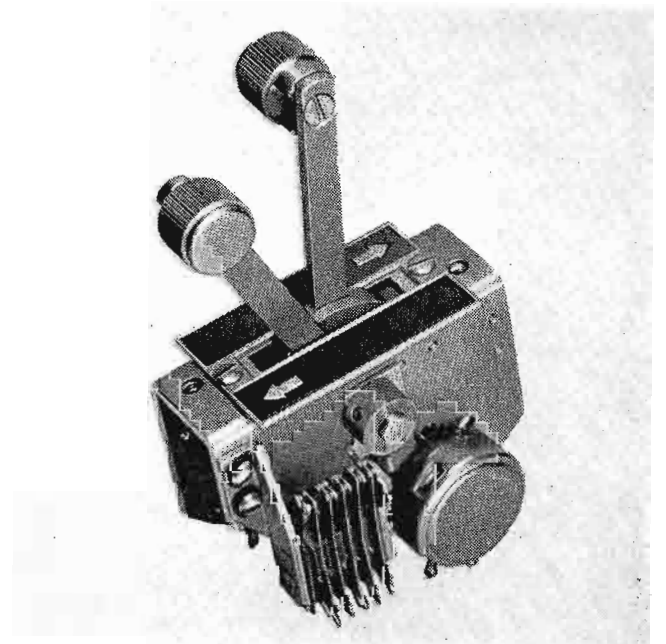

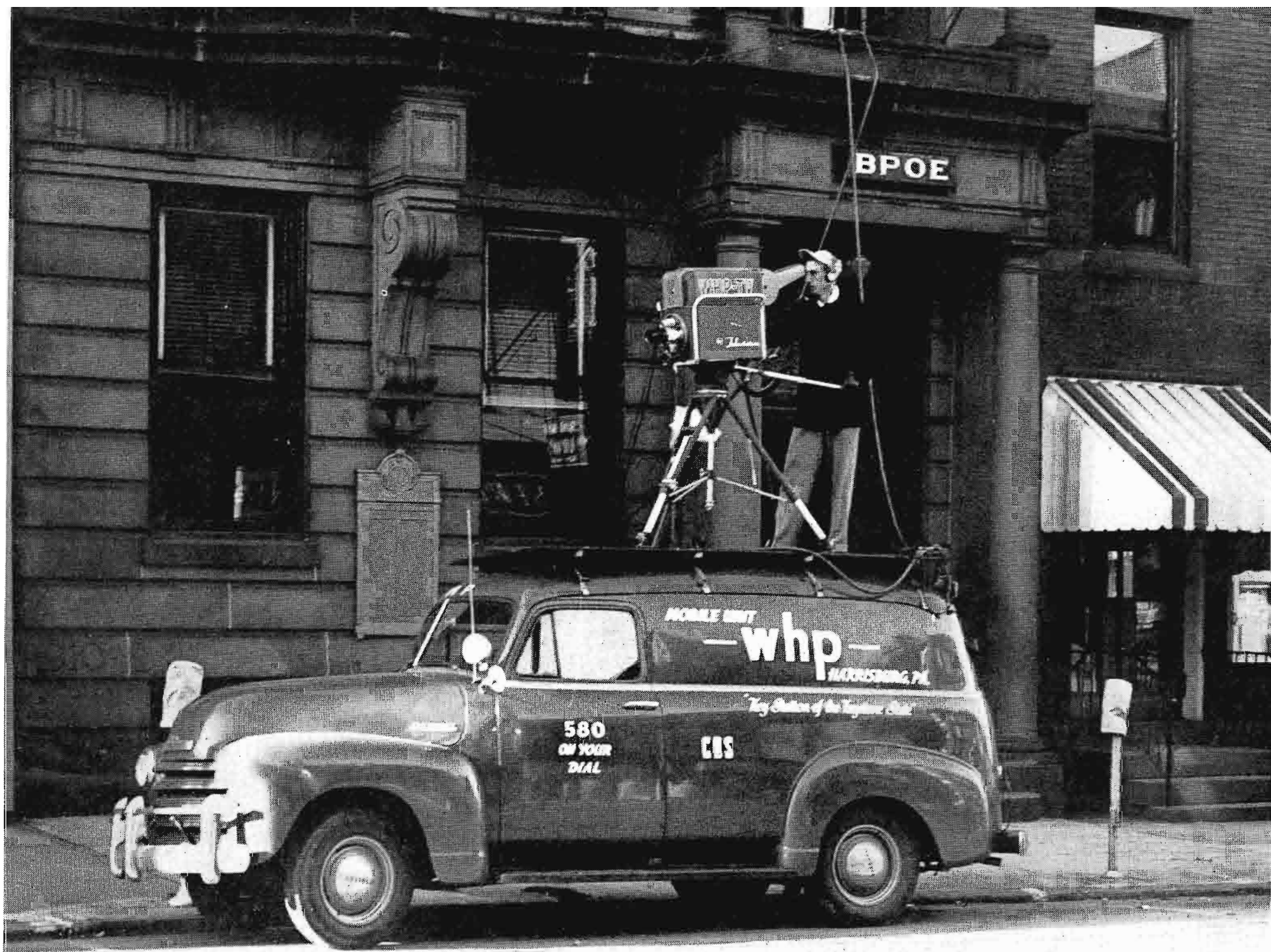

FIG. 1. WHP-TV Special Events unit makes early morning checks just prior to telecasting Christmas Parade. Audio and camera controls are set up inside the Elk's Home. Bob Poorman is the cameraman. Unit can move within one hour's time.

WHP-TV, HARRISBURG... UHF PROVING GROUND

Harrisburg's first television station, WHP-TV (CBS affiliate), is now rounding out fourteen months of operation since it helped pioneer the commercial use of new and improved UHF transmitting equipment. The result is that this nine county area of Central Pennsylvania, of which Harrisburg (Pennsylvania's capital) is the center, is now a thriving television area.

At WHP-TV "UHF is Really ULTRA"

Set sales, and conversions, show the area to be one of the major UHF centers of the nation. Due to the consistency of picture clarity, plus saturation coverage from tower base to horizon, it was in Harrisburg that the phrase was coined that "UHF Is Really ULTRA". Scores of engineers who have visited the station to study the operation first hand have come away with the decision that the new RCA antenna, matched to the transmitting site, is the secret.

By **DICK REDMOND**
Program Director, WHP-TV

The station's Blue Mountain site affords maximum coverage of Harrisburg proper and acts as a hub for transmission to the surrounding nine county area whose cities and towns in both a geographical and marketing sense are closely connected with the capital city of Pennsylvania. The transmitter site affords line of sight vision that includes all of Harrisburg, the rapidly growing suburban communities and such central Pennsylvania towns as Lebanon, York, Lancaster, Elizabethtown, Steelton, Middletown, Carlisle, Mechanicsburg, Hershey and points in between.

The site elevation at ground level is approximately 1300 feet above Harrisburg and the immediate surrounding terrain. This plus the proximity of the tower site to Harrisburg and the use of a short tower

(180 feet) actually duplicates a somewhat impressive but also very expensive tower height of approximately 1500 feet.

Phenomenal Coverage Attributed to Antenna Design

The story of WHP-TV's tower provides one of the more interesting aspects of the construction project. It all started with a telephone conversation between station manager A. K. Redmond and RCA representative Ed Clammer. At the time, the industry, based on the experience of existing UHF stations, was well aware of coverage insufficiencies existing in some antenna designs. To cope with the problem of nulls or undependable signal strengths, RCA designed an antenna that from all indications observed in field tests, would provide the type of coverage stations wanted and needed. Mr. Clammer's enthusiasm for RCA's new electronically tilted antenna—the TFU-27BHS—was



FIG. 2. WHP-TV's Chief Engineer, Dan Leibensperger, is shown at transmitter controls. Transmitter is the RCA TTU-1B.

matched by the enthusiasm of Mr. Redmond and WHP-TV's Chief Engineer Dan Leibensperger. An RCA experimental antenna, which by coincidence was tuned to Channel 55, had proved that it would do

away with nulls in the vicinity of the antenna. This antenna, utilizing eighteen layers with off-center (fed between the 8th and 9th layer) feed and a one degree downward tilt, offered advantages for

WHP-TV's maximum usable power. Mr. Clammer met with station management and Robin D. Compton of the George C. Davis office, the station's consultant, at which time it was decided that the new

FIG. 3. Floor plan showing the WHP-TV Transmitter Building layout.

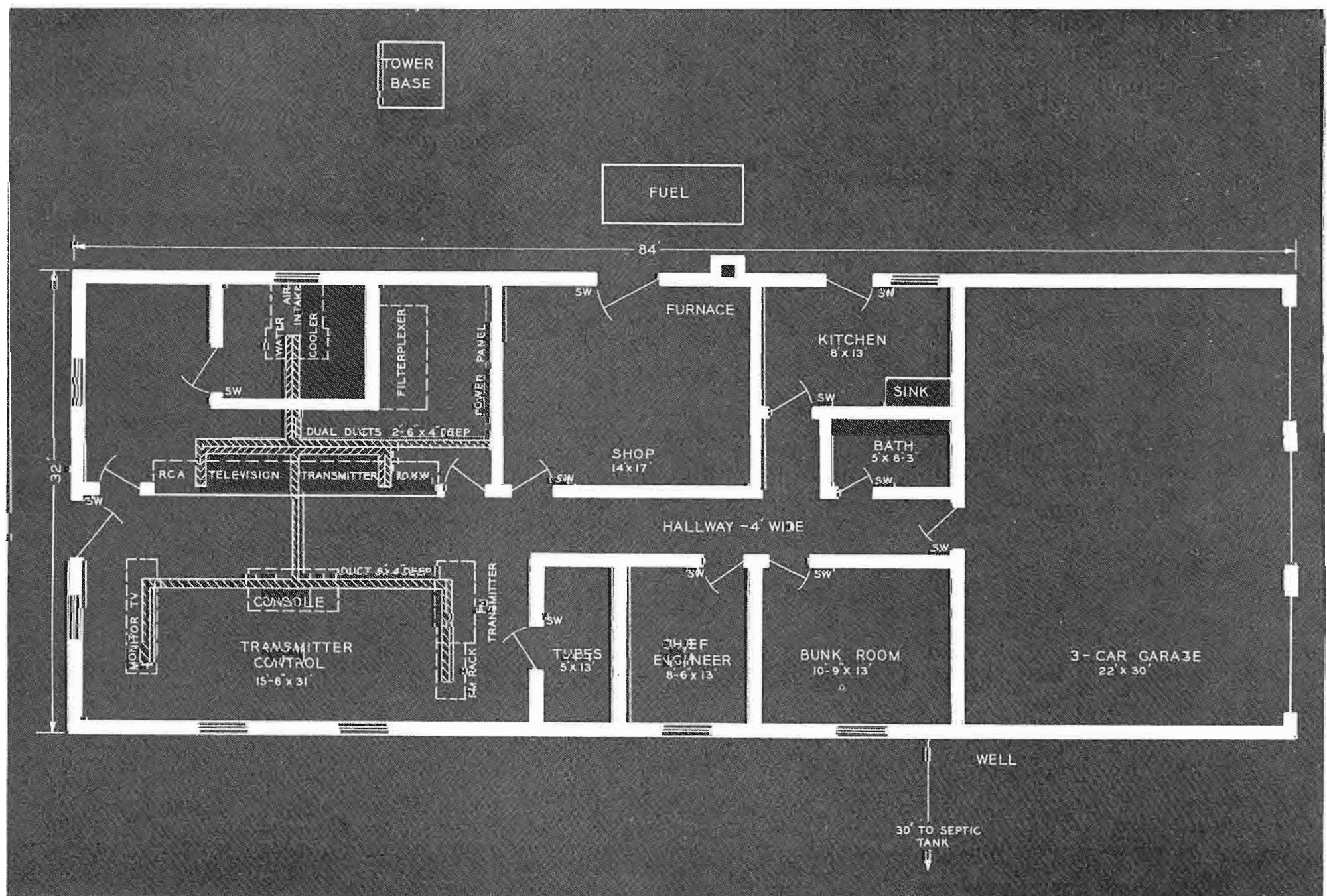

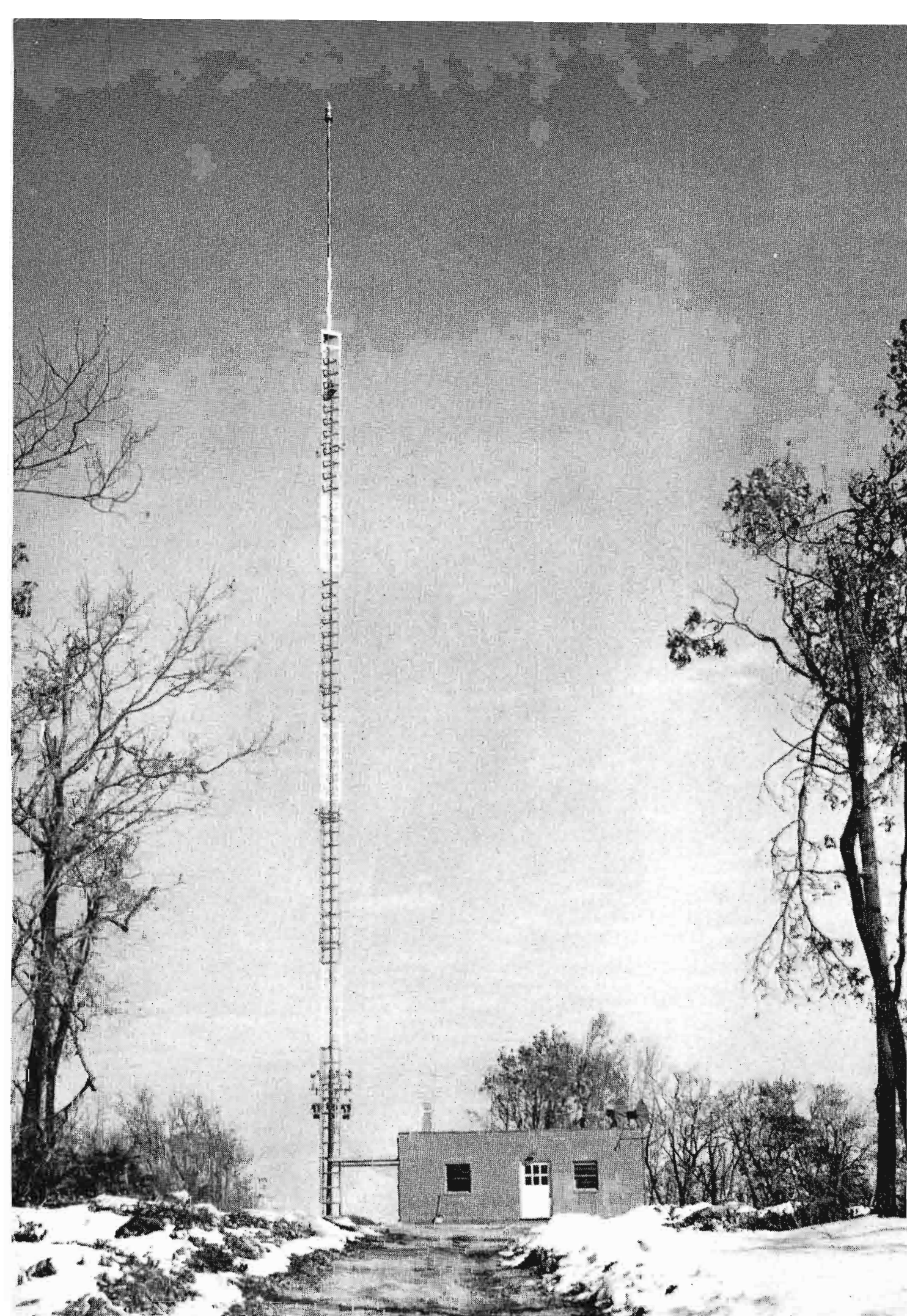

FIG. 4. WHP-TV Tower and Transmitter Building. Piercing the sky above Blue Mountain, the WHP-TV tower and antenna is only 180 feet, but situated as it is on the highest peak of the surrounding area (1310 ft.), is considered by engineers to be the ideal working combination in giving the station its excellent signal strength and complete coverage throughout the entire Central Pennsylvania area. Incidentally, the site is situated directly on the Appalachian Trail, the famed footpath which runs from Main to Georgia, and has played such an important part in American history.

antenna would suit WHP-TV's needs admirably. Although all engineering measurements showed that the new antenna could work, it remained for WHP-TV to make the first real test.

RCA's new TFU-27BHS arrived at WHP-TV's transmitter gas-proof with a standing wave ratio of 1.03 and perfectly matched to transmission line and filter-

plexer. The antenna has fulfilled every promise, functioning perfectly from the start and gives WHP-TV a signal increase in Harrisburg and vicinity—better than eleven to one over the previous RCA antenna design.

Making an "On-Air" Date

The construction permit was issued October 1, 1952 and the following month it

was decided by management and engineering staff that the start date for test pattern operations be set at April 1st. This was done with a full awareness of the problems to be faced; however, it was felt that such a decision was necessary to satisfy the thousands of potential viewers who had been awaiting the coming of Harrisburg's first station and also to bring home to both viewers and the industry the fact that a new UHF station could be brought in on time and in perfect working order. At this same meeting WHP-TV not only committed itself to an April 1st test pattern, but also actual programming to start on April 15th. The setting and publicizing of actual dates put everyone to the test and was a great factor in overcoming problems that might easily have been relegated to the classification of impossible.

Delivery of WHP-TV's studio equipment began in January of 1953 and by March all equipment was on hand. On April 1, 1953 WHP-TV's test pattern was on the air. On April 15 at exactly one minute of eight, Mayor Claude Robbins of Harrisburg, who had been introduced by Dick Redmond, Program Director of WHP-TV, threw the switch that joined WHP-TV to the CBS television network for the Arthur Godfrey Show.

A little better than five months of planning and hard work made possible the one auspicious moment that converted Harrisburg and surrounding communities from "a fringe area" into a thriving television center.

In these five months the major projects were, of course, the construction of the transmitter, studios and installation of equipment and relay systems.

The Transmitter Building

The transmitter building, designed by WHP-TV's Chief Engineer, Dan Leibensperger, measures 84 by 36 feet and is of fireproof construction, utilizing cinder block, steel, brick and concrete. Its steel mesh and concrete roof is supported by precast concrete and steel beams and is designed to hold four inches of water for insulation and fire protection. The building was constructed not only to house present equipment and staff but with space for additional personnel and equipment up to 1,000,000 watts.

The transmitter includes space for personnel and station vehicles, a bunk-room, bath and shower, fully equipped kitchen, Chief Engineer's office, spare parts storage, furnace room and main transmitter room. The transmitter is so installed as to assure

shortest possible runs from transmitter to filterplexer to tower which is located just ten feet from the main building. In order to obtain the best acoustical qualities the ceiling of the main transmitter room is constructed of special acoustical-perforated metal plates backed with three inches of glass wool. The transmitter building also provides room for an auxiliary gasoline or Diesel generator in case of power failures. Because of the possibility of personnel isolation during severe winter storms, the transmitter interior and furnishings offer pleasant, comfortable surroundings for times of enforced residence and off duty hours.

WHP-TV Studios

The WHP-TV studios which are located in the Telegraph Building in downtown Harrisburg, occupy the space which was formerly used by WHP-Radio. The entire fourth floor of the well known downtown building has been converted into television studio facilities. The studios are two in number with the main studio measuring 57 by 45 feet and a news and special events studio 16 by 20 feet.

Equipment-wise WHP-TV is geared for ambitious local programming with four cameras which enable the station to take remote pickups without curtailing studio programs. The station also has its own micro-wave gear, in duplicate, one set linking studios and transmitter, another used for remotes.



FIG. 5. Ralph Sherrick threads films in WHP-TV's film room, directly to the rear of control room.

A specially designed lighting system makes available 66,000 watts which are controlled by a dimmer board with six dim and six no-dim circuits. The 66,000 watts of lighting are shared by 145 lighting fixtures which can be hooked into either dimmer circuit. The system is com-

pletely flexible, consisting of overhead lights, spots and lighting on dollies. Studio flexibility extends itself to the rear screen projector which can be used in any outlet, making possible complete freedom of movement to any part of the studio, thus creating best possible conditions for local

FIG. 6. WHP-TV's studios and offices located in downtown Harrisburg, Pa.

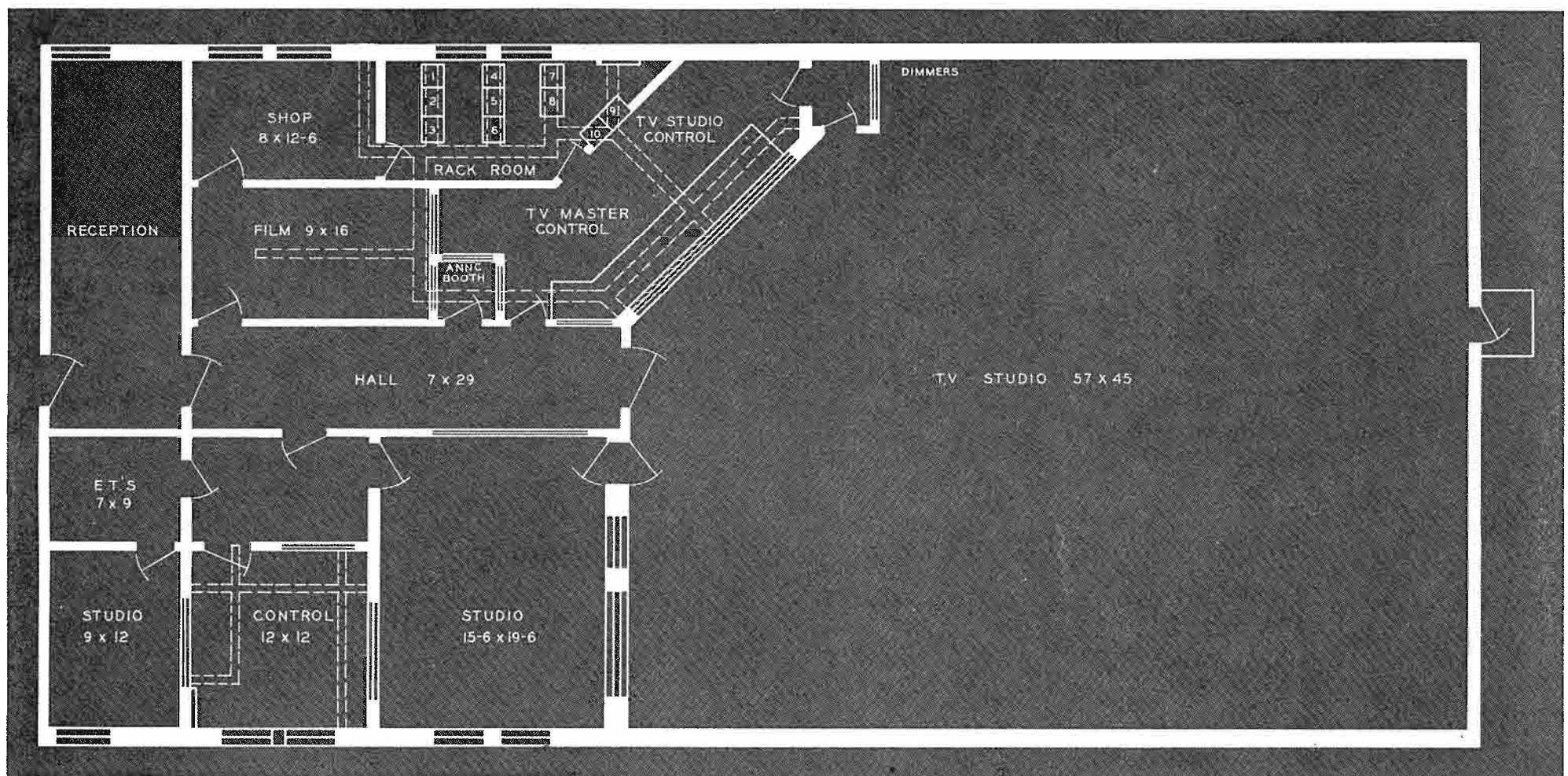



FIG. 7. One of WHP-TV's popular local features is Cafe Danube, in which old world charm of the side-walk cafe is realistically presented. (Note how set can be stripped down and used for other shows. See Fig. 8 below.)

FIG. 8. WHP-TV sets are designed for adaptability and convertibility such as set shown below used in the station's very popular Barber Shop Quartette series which brought in singing groups from all Central Pennsylvania. (Note that this is same basic set as cafe scene above with door, barber pole, and window blind added, and shutters, tables, window and door coverings removed.)



programming. Master and studio control are built across one corner of the main studio so as to give full view of activities in both studios from either control room.

Immediately adjacent to the control rooms is located the rack room which contains power supplies, distribution amplifiers, two sync-generators, audio distribution systems and Genlock. Also connected to the master and studio control is the projection room which contains a film camera chain with two 16mm projectors and a Gray Telecaster. Provisions have been made for additional space for another camera chain. All wiring between rack room, control, projection room and studios is enclosed in sheet metal ducts under plywood panels which form part of the floor. The projection room is completely screened with Copraloy to eliminate any possibility of picking up radio frequency energy originating in local AM broadcast stations located in the immediate vicinity.

The third floor of the Telegraph Building houses reception room, administrative offices, dressing rooms, prop rooms, photo and art departments. Strategically located passenger and freight elevators expedite communication and traffic between studios, offices and storage.

Audio/Video Facilities

WHP-TV's audio facilities include approximately 24 lines to permanently installed remote locations making them all available for AM, FM and TV pickup. Audio facilities are rounded out by two 15,000 cycle-equalized lines to TV transmitter and magneto and business telephone. Video facilities include two complete STL's, one of which can be used on standby while the other is used for regular program channel.

WHP-TV is interconnected with CBS television at the terminal point for microwave facilities located at Clark's Knob. The interconnection which covers a distance of approximately 35 miles is made in two hops with the intermediary point being Waggoner's Gap. The connection is completed with station facilities and the central office connected by video pairs.

WHP-TV Has a "Planned" Future

There has been no baleful cry of "If we had it to do over" at WHP-TV. Careful planning and timely execution of these plans all made possible by close-knit cooperation and hard work, have created television facilities which have proved ample for the present and immediate future, and if and when the occasion should come about, they could rise to meet new demands in both material and personnel.

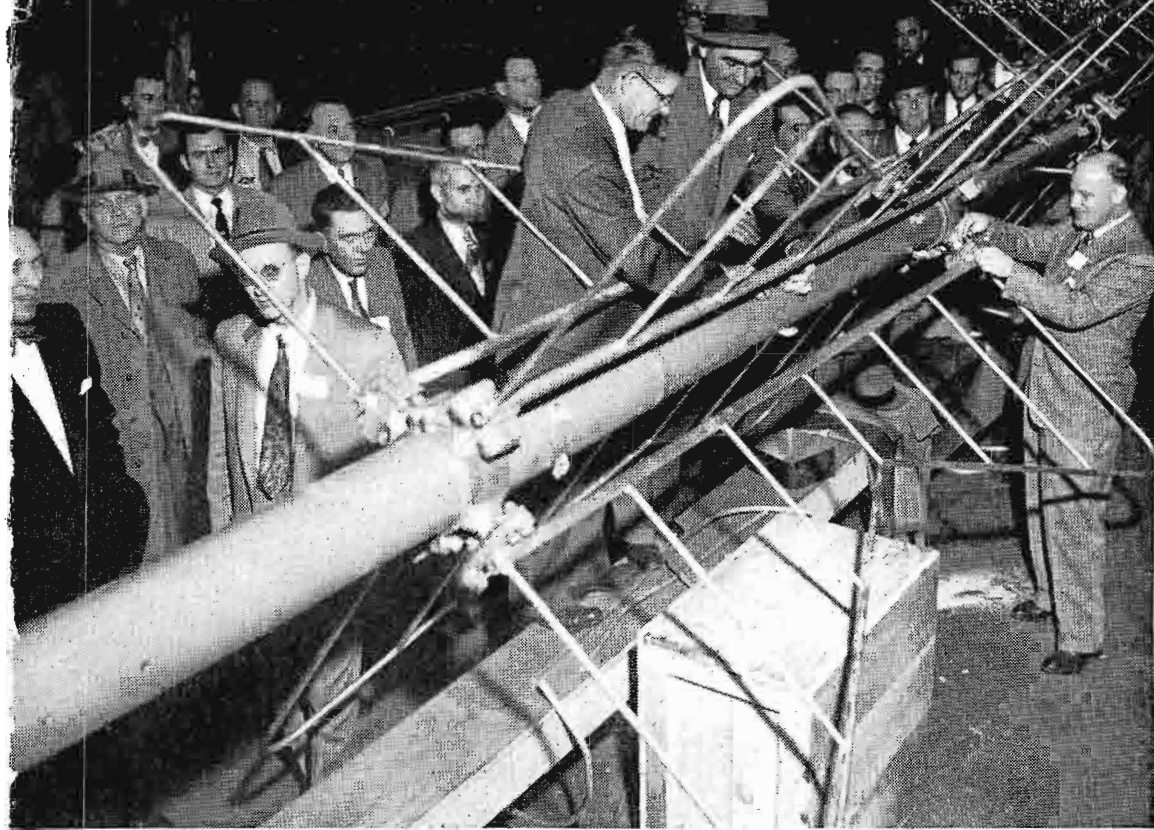

A. H. Super, of RCA, accompanies the Erectors' Forum group during a demonstration of the Superturnstile Antenna.

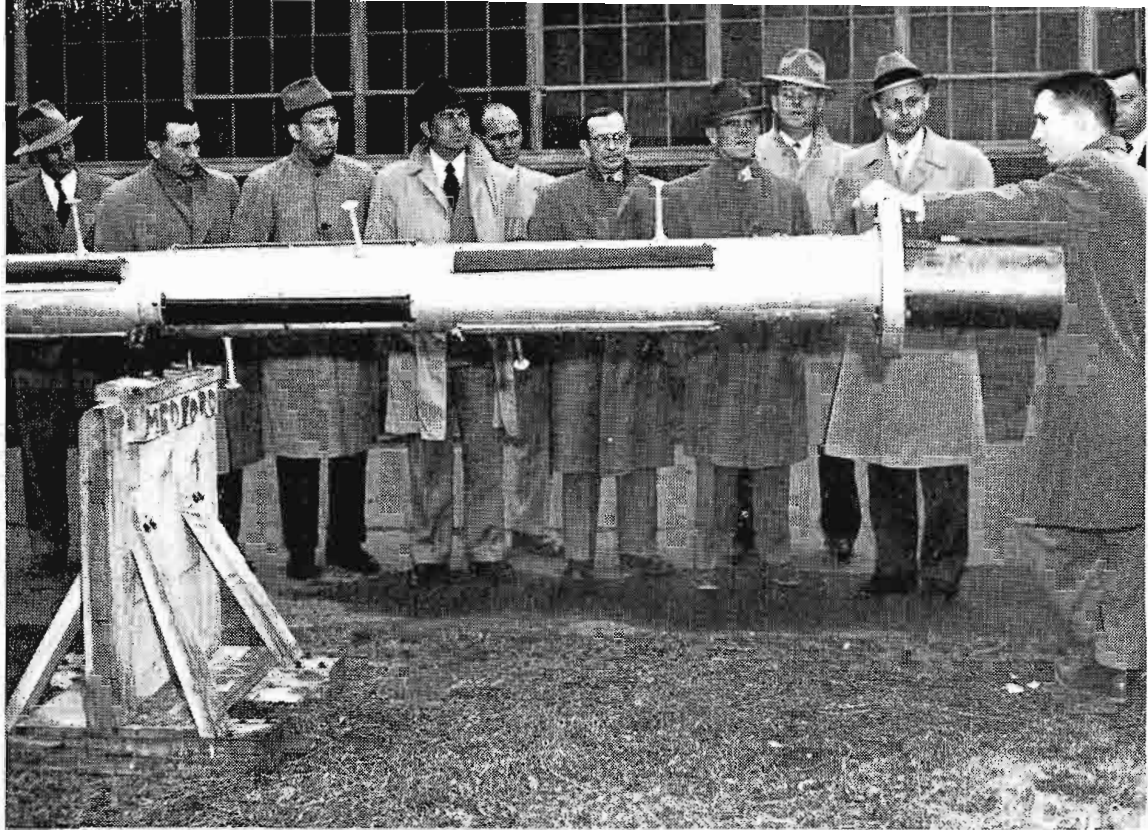

E. H. Shively, of RCA, demonstrates the requirements of erecting the UHF Pylon Antenna.

RCA HOLDS ANTENNA ERECTORS' FORUM

The 2nd Erectors' Forum, held at the RCA Plant in Camden, N. J. was launched on Tuesday morning, March 30. This meeting is conducted for the purpose of demonstrating to the personnel of antenna and tower erecting firms the correct and up-to-date methods used to assemble and install RCA Television Broadcast antennas and transmission lines.

The two-day session was opened with a welcome by T. A. Smith, Vice-President, Engineering Products Division, RCA. The meeting was conducted by A. H. Super.

The Tuesday program included an introduction to antenna erection techniques by H. E. Gihring; a lecture on "VHF Super-

turnstile Antennas," by H. H. Westcott; "Custom Built Antennas," R. H. Wright; "UHF Antennas," O. O. Fiet; "Transmission Lines," W. N. Moule; "Insurance," G. H. Schmidt.

Following the Tuesday luncheon at a nearby Camden restaurant, a chartered bus whisked the visitors away to the RCA Antenna Test Site. Here a demonstration of VHF antennas, components, pre-assembly procedure and ground assembly was conducted by G. A. Kumpf, G. W. Mordan and J. Bernbaum.

After the day's demonstration the guests were returned by chartered bus to their hotel in Central Philadelphia . . . across the river from Camden, N. J.

Wednesday's program included further demonstrations at the RCA Antenna Test Site on "UHF Antennas" by E. H. Shively; "Transmission Line and Waveguide," W. N. Moule, and the usual social gathering of a noonday luncheon. The afternoon completed the two-day activity with a return to the RCA "Little Theatre" for a general review and discussion. As in previous Forums of this kind each visitor left with two specially prepared booklets . . . "Erecting RCA VHF Superturnstile Television Antennas"—"Erecting RCA UHF Pylon Television Antennas" and the gratifying experience of having learned much about an exacting skill . . . the erection of towers and antennas which dot the nation.

— LIST OF THOSE IN ATTENDANCE —

FIRM NAME	REPRESENTATIVES	FIRM NAME	REPRESENTATIVES	FIRM NAME	REPRESENTATIVES
Allied Construction Company Wichita Falls, Texas	Mr. B. J. Marak	Heron Todd Steel Construction Co. Arlington, Virginia	Mr. I. K. Gruver, Jr. Mr. J. W. McDaniels	Racine Tower Construction Co. Brandon, Vermont	Mr. E. S. Crosby
Alpha Erection Company Iowa City, Iowa	Mr. T. Kirkman	Hamilton & Company, J. M. Gastonia, North Carolina	Mr. J. M. Hamilton	Radio Construction Company Pittsburgh, Pennsylvania	Mr. D. E. Phillips, Jr.
Beasley Construction Company Muskogee, Oklahoma	Mr. L. E. Berg Mr. B. Pruden	Ideco Division, Dresser-Stacey Co. Columbus Ohio	Mr. J. A. Jackson Mr. P. B. Erwin	Seago Construction Company Dallas, Texas	Mr. H. P. Tiner Mr. C. A. McLarty
Electrical Tower Service Peoria, Illinois	Mr. C. Lomas Mr. J. Streamer	Kline Iron & Metal Company Columbia, South Carolina	Mr. F. L. Anderson Mr. F. M. Smith	Stainless Incorporated North Wales, Pennsylvania	Mr. P. Louquet Mr. R. Wolfe Mr. R. J. Eberle
Emsco Manufacturing Company Houston, Texas	Mr. L. Doering Mr. J. Lee	Macco Corporation Paramount, California	Mr. H. Green	Tower Construction Company Sioux City, Iowa	Mr. T. Gray
Furr & Edwards Construction Co. Rome, Georgia	Mr. W. Furr Mr. B. Furr	Olsen Corporation, G. A. New York, New York	Mr. G. A. Olsen Mr. A. Olsen	Wind Turbine Company West Chester, Pennsylvania	Mr. C. Abel Mr. F. H. Lukens
Henkels & McCoy Contractors Philadelphia, Pennsylvania	Mr. G. Conaway Mr. C. Fetters	Parkersburg Rig & Reel Company Parkersburg, West Virginia	Mr. J. R. Stevens	Zane Construction Company West Orange, New Jersey	Mr. H. B. Zane

Photos taken during the Wednesday afternoon luncheon at the Erectors' Forum.

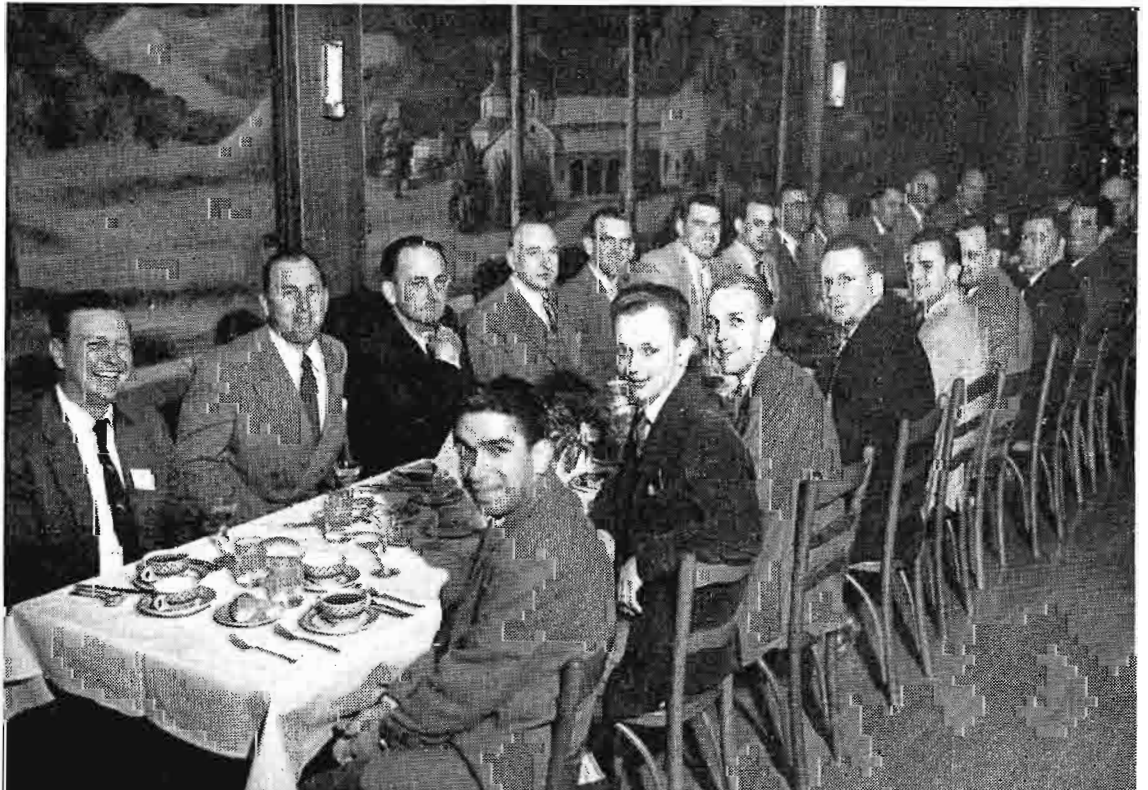
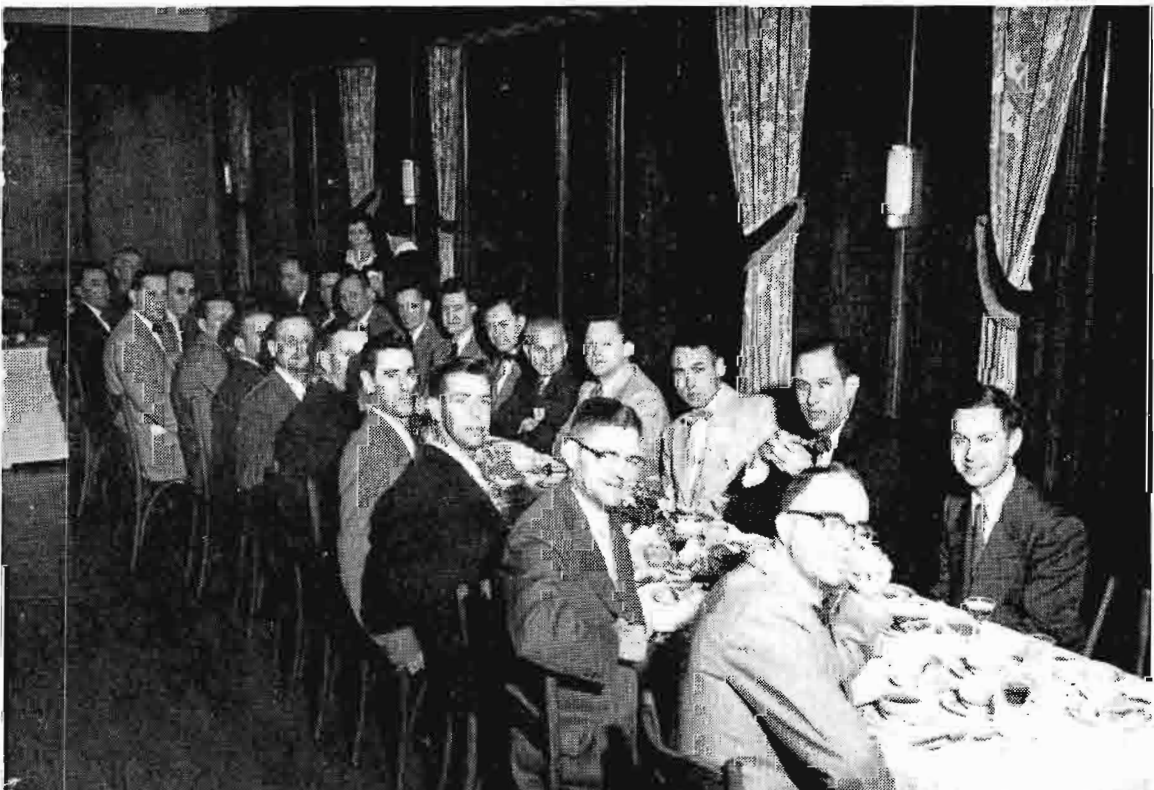



Very popular among RCA Institutes courses is the 1½ year Radio and Television Broadcasting course. Here a student enrolled in this sequence adjusts an RCA Transmitter.

BROADCASTING AND RCA INSTITUTES

by **C. E. TOMSOM**
Registrar, RCA Institutes, Inc.

One of the significant facts of technical training today is that graduates of reputable schools are rapidly absorbed by electronic manufacturers and other organizations. Statistics show that many more qualified technicians can be employed by industry than are being enrolled in technical institutes and colleges.

RCA Institutes is one of those schools, now training electronic technicians. It was founded in 1909 when radio had not yet become complicated. In those days, a radio was very simple and could easily be chalked up on a blackboard by an instructor. Because so little was known about "wireless,"

A lecture in TV servicing using "dynamic demonstrator."

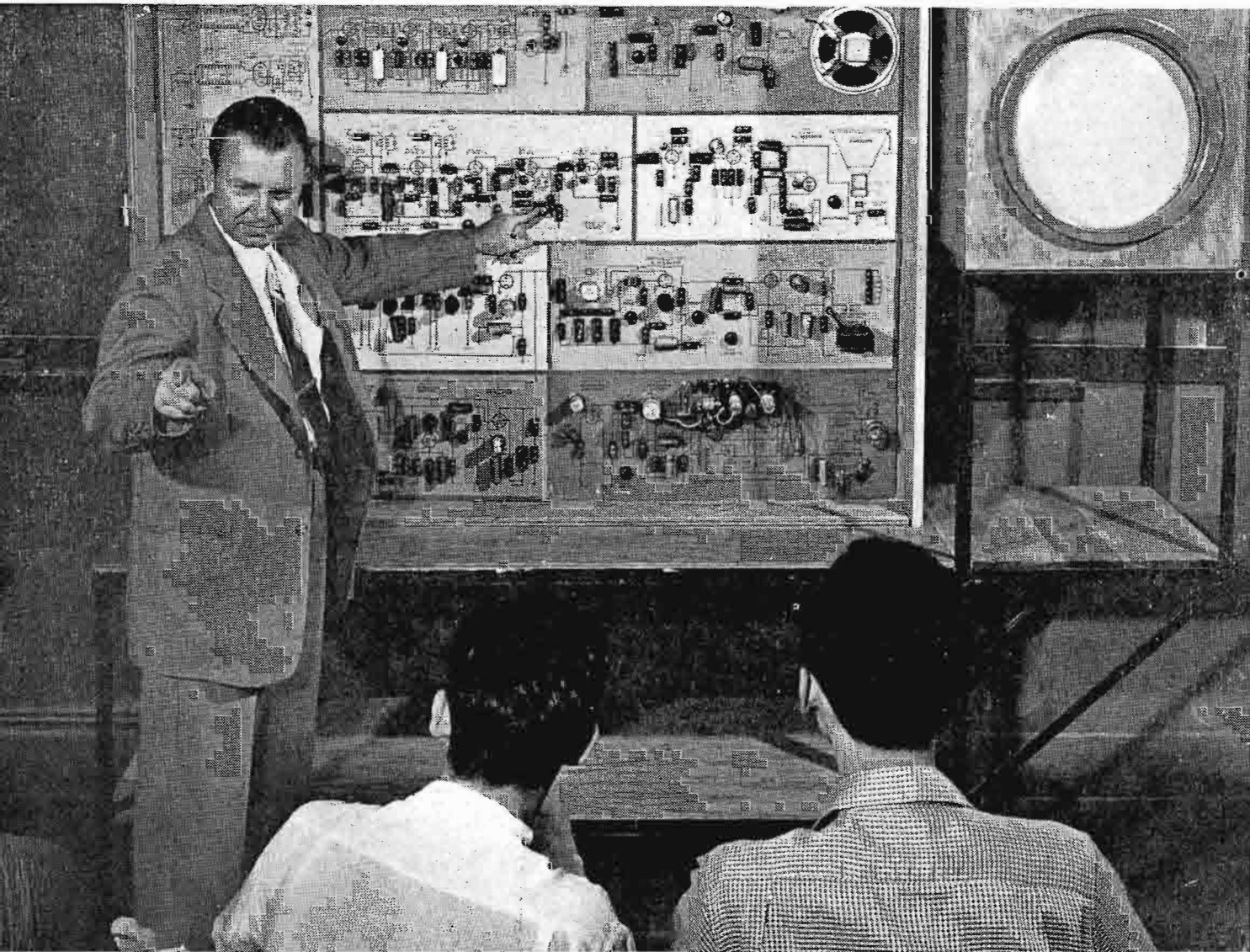

a course covering both theory and practice could be completed in two weeks.

By contrast, today's Advanced Technology course requires full time attendance, five hours per day, for two and one-quarter years. This course is especially attractive to high school graduates and offers instruction in the operation, maintenance and development of all types of radio circuits. The program stresses technical instruction at collegiate level in electricity and radio and television. So thorough is the course that those who complete it are often granted appreciably advanced standing when applying for admission to engineering colleges and universities. Engineering school graduates, desiring a more thorough knowledge of the communication field, find the specialized material in the upper terms of great interest. Supplementing regular academic instruction, students are taken on inspection trips to important broadcasting and industrial centers located in the greater New York-New Jersey area. Graduates are thus prepared to enter directly into the electrical communication field as studio or transmitter technicians with radio and TV broadcasting companies, in research or laboratory work with manufacturing organizations and in many other positions where a comprehensive knowledge of the science of electronics is required.

Another course preferred by hundreds of students each year enter the popular one and one-half year Radio and Television Broadcasting course. Increasing installations of radio and television facilities have created a demand for many more laboratory technicians and station engineers. Besides the techniques of radio and TV servicing, the course offers instruction in station operation and television operating procedure.

Many veterans now being released from the armed services sense career possibilities in the vast growing radio-television field. A great number received sufficient training while in service to realize the potential scope of electronics. Qualified veterans seeking enrollment under Public Laws 550, 346 and 16 are encouraged to enter these courses.

RCA Institutes also offers courses in Radio Telegraph Operating, Radio and Television Servicing and Advanced Television Servicing. The school expands its curricula as necessary to match the tremendous expansion in the field of electronics. In succeeding semesters, there will be classes in the newly approved color television system. Classes in transistors, computers and radar are also scheduled with the expectation that these groups will be made elective in the regular curriculum of the school.

Sound motion pictures, disc and tape recorders and slides are used to supplement instruction in all courses. The practices followed in lecture and laboratory classes must meet the approval of the Institutes' Board of Technical Advisers. Members of the Board are leading engineers of the Radio Corporation of America.

Prospective students are invited to visit the school and discuss their proposed training with the school's counseling staff. Proper guidance before enrollment minimizes scholastic difficulties and aids the student in his selection of a training program.

The school encourages outstanding high school seniors by awarding three annual scholarships, including books and supplies, worth approximately \$1,500.00 each. The winners of the scholarships are determined by competitive examination.

In common with other schools, most of the students at RCA Institutes come from nearby areas. However, the impact of the Electronic Age has induced many young men to travel thousands of miles to acquire the technical knowledge necessary to operate and service commercial equipment. During the past decade, students have matriculated from Argentina, Bermuda, Brazil, Canada, Chile, Cuba, Ecuador, Greece, Iceland, India, Iraq, Israel, Liberia, Mexico, Pakistan, Panama, Peru, Singapore, Thailand, Turkey, Venezuela and many other

countries. Every consideration is given to students from abroad so that upon return to their homelands they have an appreciation and an understanding of the American way of life. They return to their own communities skilled in a specialized art and as interpreters of what they have learned, felt and seen while students in the United States.

In addition to the above programs, RCA Institutes offers home study courses to help those unable to attend resident school classes. A new color TV home study course is offered for technicians in this electronic field. These home study or correspondence courses are available to persons employed in the radio-television industry.

RCA Institutes is a Service of the Radio Corporation of America. The school is located at 350 West Fourth Street, New York City, where it now occupies 40,000 square feet on the second and third floors. Day and Evening classes are conducted during forty-nine weeks of the year. New terms begin approximately the first of March, June, September and December. The school is a member of the New York State Association of Junior Colleges, The American Society for Engineering Education, The Private Vocational Schools Association of New York, Inc., and an affiliate member of the Greater New York Council for Foreign Students.

Technical instruction at RCA Institutes is at collegiate level. Pictured here is a demonstration lecture in one of the basic physics courses.

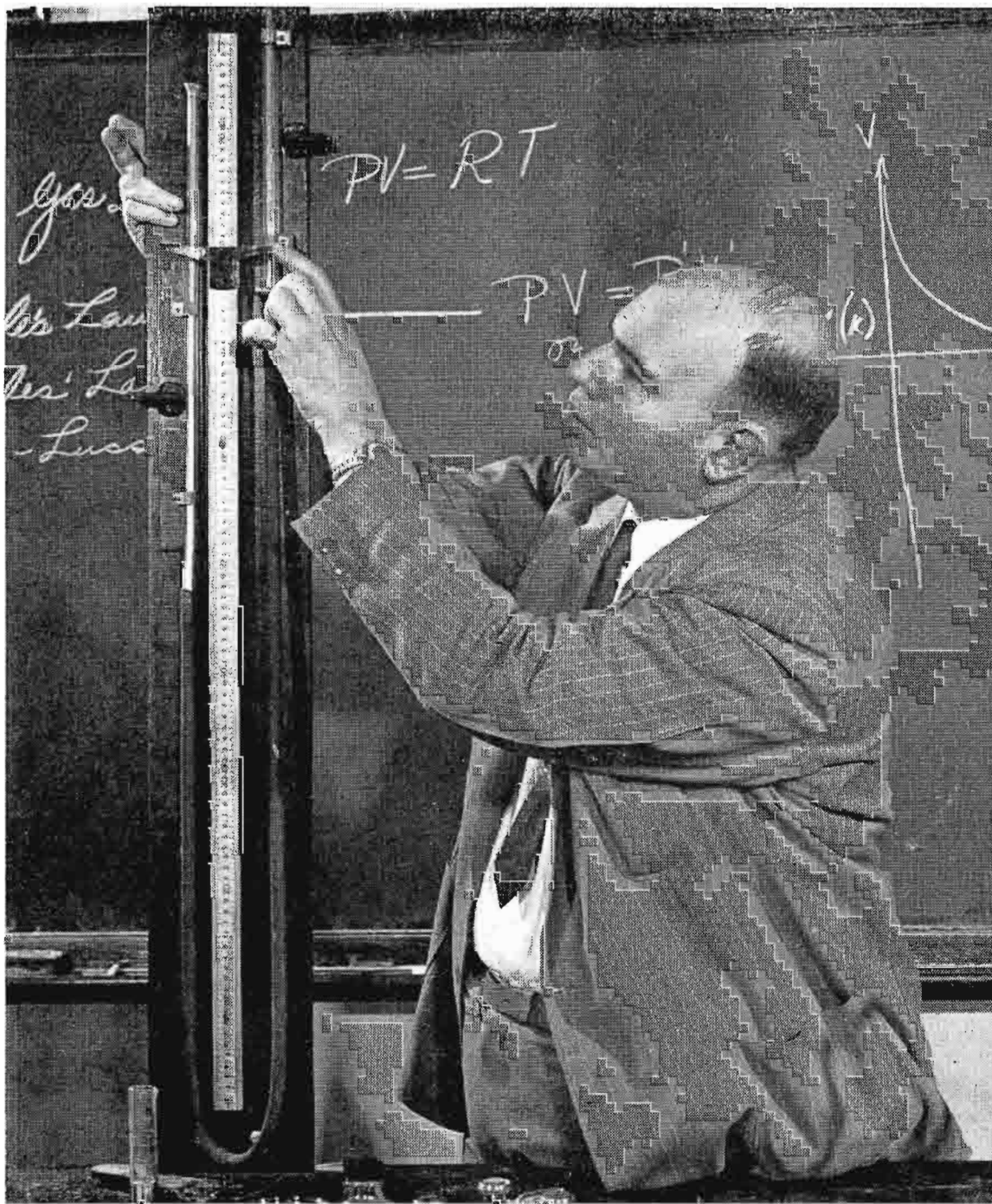

RCA BROADCAST

J. A. (JULES) RENHARD
2250 First Ave., South
Seattle 4, Washington
Telephone: Maine 8350

R. J. (DICK) NEWMAN
1355 Market Street
San Francisco 3, California
Telephone: Hemlock 1-8300

W. G. (WOODY) EBERHART
666 N. Loke Shore Drive
Chicago 11, Illinois
Telephone: Delaware 7-0700

E. (JACK) FROST
1560 North Vine Street
Hollywood 28, California
Telephone: Hollywood 9-2154

C. A. (CHET) WALLACH
P.O. Box 6616
3300 E. 43rd Ave.
Denver, Colorado
Telephone: Acoma 8-8963

W. B. (WALT) VARNUM
340 Dierks Building
1006 Grand Avenue
Kansas City 6, Missouri
Telephone: Harrison 6480

EDWARD (ED) EDISON
1560 North Vine Street
Hollywood 28, California
Telephone: Hollywood 9-2154

J. F. (JOHN) PALMQUIST
1907-11 McKinney Ave.
Dallas 1, Texas
Telephone: Riverside 1371

J. N. (JIM) BARCLAY
1907-11 McKinney Avenue
Dallas 1, Texas
Telephones: (Dallas) Riverside 1371
(Austin) Austin 2-5055



RADIO CORPORATION of AMERICA
ENGINEERING PRODUCTS DIVISION
CAMDEN, N.J.

REPRESENTATIVES

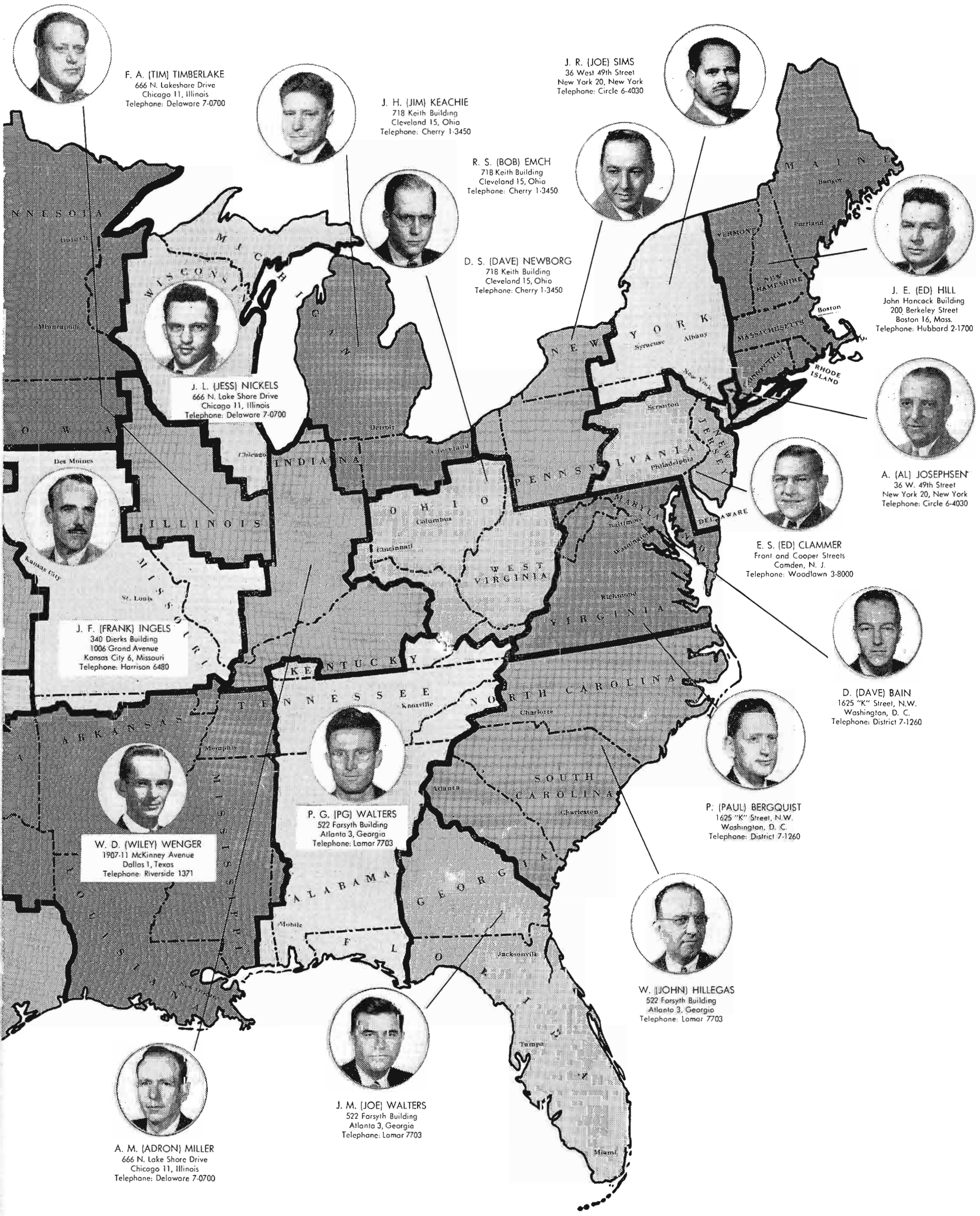

F. A. (TIM) TIMBERLAKE
 666 N. Lakeshore Drive
 Chicago 11, Illinois
 Telephone: Delaware 7-0700

J. H. (JIM) KEACHIE
 718 Keith Building
 Cleveland 15, Ohio
 Telephone: Cherry 1-3450

J. R. (JOE) SIMS
 36 West 49th Street
 New York 20, New York
 Telephone: Circle 6-4030

R. S. (BOB) EMCH
 718 Keith Building
 Cleveland 15, Ohio
 Telephone: Cherry 1-3450

D. S. (DAVE) NEWBORG
 718 Keith Building
 Cleveland 15, Ohio
 Telephone: Cherry 1-3450

J. E. (ED) HILL
 John Hancock Building
 200 Berkeley Street
 Boston 16, Mass.
 Telephone: Hubbard 2-1700

J. L. (JESS) NICKELS
 666 N. Lake Shore Drive
 Chicago 11, Illinois
 Telephone: Delaware 7-0700

A. (AL) JOSEPHSEN
 36 W. 49th Street
 New York 20, New York
 Telephone: Circle 6-4030

J. F. (FRANK) INGELS
 340 Dierks Building
 1006 Grand Avenue
 Kansas City 6, Missouri
 Telephone: Harrison 6480

E. S. (ED) CLAMMER
 Front and Cooper Streets
 Camden, N. J.
 Telephone: Woodlawn 3-8000

D. (DAVE) BAIN
 1625 "K" Street, N.W.
 Washington, D. C.
 Telephone: District 7-1260

W. D. (WILEY) WENGER
 1907-11 McKinney Avenue
 Dallas 1, Texas
 Telephone: Riverside 1371

P. G. (PG) WALTERS
 522 Forsyth Building
 Atlanta 3, Georgia
 Telephone: Lamar 7703

P. (PAUL) BERGQUIST
 1625 "K" Street, N.W.
 Washington, D. C.
 Telephone: District 7-1260

A. M. (ADRON) MILLER
 666 N. Lake Shore Drive
 Chicago 11, Illinois
 Telephone: Delaware 7-0700

J. M. (JOE) WALTERS
 522 Forsyth Building
 Atlanta 3, Georgia
 Telephone: Lamar 7703

W. (JOHN) HILLEGAS
 522 Forsyth Building
 Atlanta 3, Georgia
 Telephone: Lamar 7703



IT'S UNOBTUSIVE. Umber gray coloring blends it right into the TV picture. Minimum reflection.

In the show . . . without stealing the act

RCA's new ribbon-pressure **"STARMAKER"***

SO SLIM YOU MUST LOOK sharply to see it . . . so skillfully styled its shape and coloring fade right into the scene . . . this tubular microphone has won the favor of entertainers and announcers wherever it has been shown.

Designed by RCA Laboratories after more than three years of painstaking research, the STARMAKER meets the long need of broadcasting, television, and show business for a high-fidelity microphone that—will not hide the features of performers—is easier to handle—and yet retains all the high-quality features of RCA professional microphones. Pick-up is non-directional. Frequency response is uniform, 50 to 15,000 cps.

Here is a "carry-around" microphone free from wind blast and air rumble. It contains no tubes, no condensers, no high-impedance circuits, no special amplifiers, or power supplies—is virtually impervious to mechanical shock.

The STARMAKER fits any standard microphone stand . . . and can be substituted for any professional high-quality RCA microphone. *No extra attachments needed!*

For price and delivery, call your RCA Broadcast Sales Engineer. Or write Dept. PB 19, RCA Engineering Products, Camden, N. J.

**Selected from entries submitted by Broadcast Stations in national contest.*



IT'S COMFORTABLE TO HANDLE . . . weighs only 1 lb.

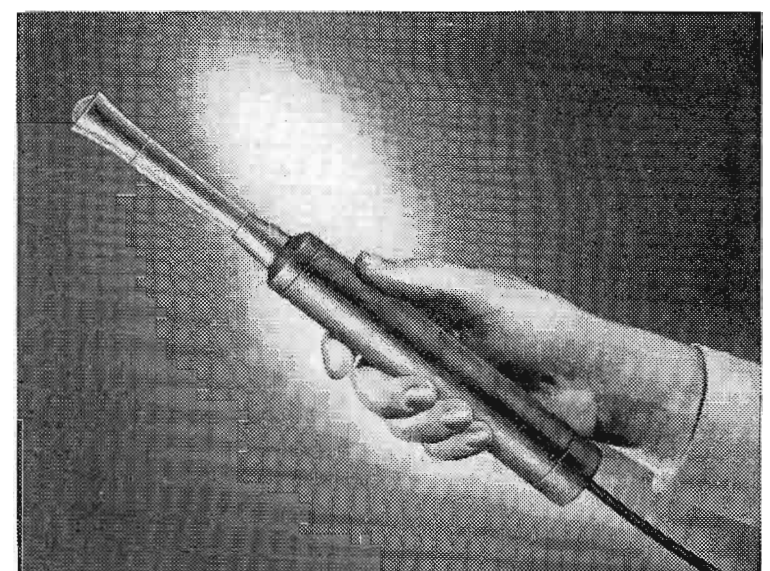

IT'S SMALL. Diameter of body is only 1¼ inches. Diameter of pick-up point is only ⅜ inch!



AUDIO BROADCAST EQUIPMENT
RADIO CORPORATION of AMERICA
ENGINEERING PRODUCTS DEPARTMENT, CAMDEN, N. J.

In Canada: RCA VICTOR Company Limited, Montreal

Completely Matched TV Systems

from one dependable source — **RCA!**



TO GET PEAK PERFORMANCE from your TV system, every unit from transmitter to antenna must match precisely!

RCA can supply Completely Matched TV Systems, and the hundreds of individual components required in *any* carefully planned television plant—VHF or UHF.

Save the time it takes to shop around. Save the money it costs to make extensive and critical adjustments with mismatched components. Go RCA all the way . . . and start **RIGHT!** Your RCA Broadcast Sales Representative is ready to help you plan.

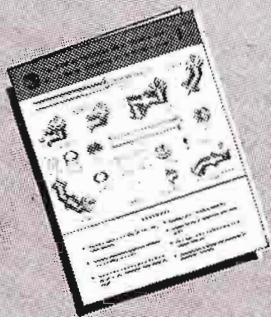

NEW comprehensive 28-page brochure on RCA UHF Transmission Lines and Fittings. Includes detailed charts, drawings, curves, installations, etc. Ask your RCA Broadcast Sales Representative for a copy.

USE THIS HANDY CHECK LIST OF MAJOR COMPONENTS

- 1 1 KW UHF Transmitter (Type TTU-1B)
- 2 3 1/8" 90° Mitre Elbow (Special Single Bullet Type)
- 3 Solder Type Flange Adapter
- 4 3 1/8" Transmission Line (Special Section Less Anchor Insulator)
- 5 3 1/8" 90° Mitre Elbow
- 6 UHF Filterplexer
- 7 Directional Coupler and Housing
- 8 Filterplexer Gassing Equipment
- 9 Line Gassing Equipment
- 10 Gas Stop
- 11 Reducer Transformer—6 1/8" to 3 1/8"
- 12 Horizontal Anchor Assembly
- 13 6 1/8" Transmission Line
- 14 Roller Assembly Support
- 15 6 1/8" Transmission Line (Special Section Less Anchor Insulator)
- 16 Lateral Braces
- 17 Two 6 1/8" 90° Mitre Elbows in Series (Combined as One Unit)
- 18 Spring Expansion Hanger
- 19 Fixed Hanger—6 1/8" Line
- 20 Two 3 1/8" 90° Mitre Elbows in Series (Combined as One Unit)
- 21 Fixed Hanger—3 1/8" Line
- 22 UHF Pylon Antenna
- 23 Beacon Assembly
- 24 Lightning Protector

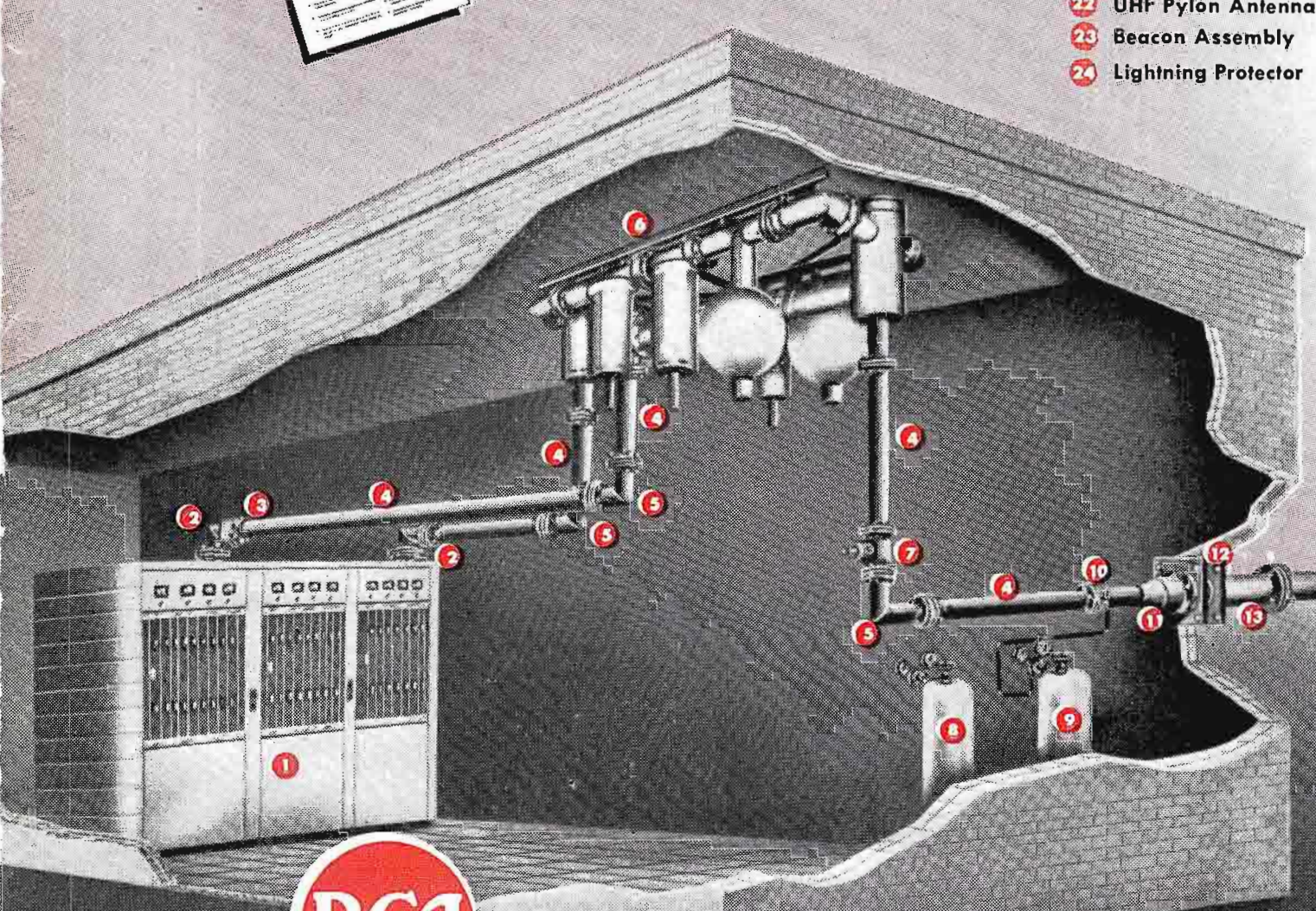
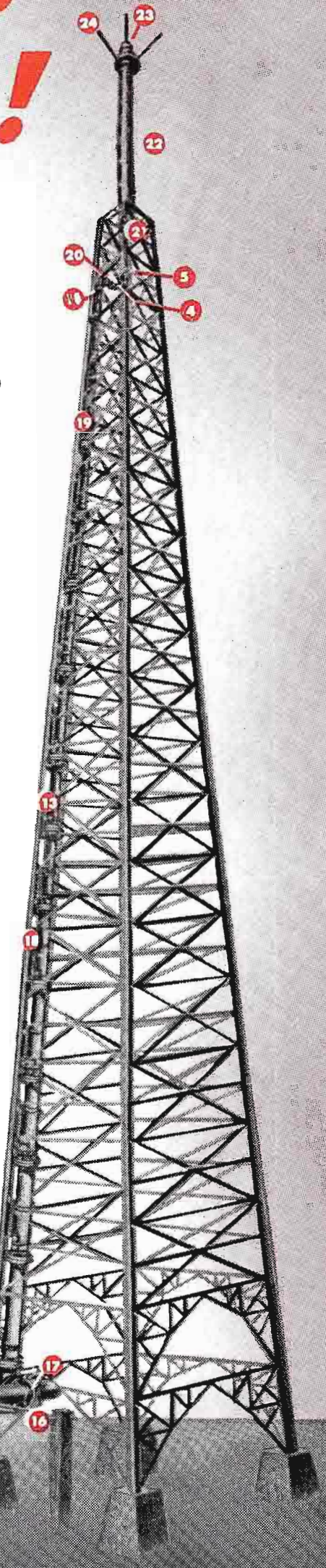

RADIO CORPORATION of AMERICA
ENGINEERING PRODUCTS DEPARTMENT
CAMDEN, N. J.

More Broadcasters
than ever before
use RCA Service...



Here's the reason why:

- RCA periodic inspections assure trouble-free operation of your UHF equipment.
- RCA Service provides all the technical assistance to get a good picture on the air, and *keep* it there.
- RCA Service is backed by all the technical and engineering facilities of the Radio Corporation of America.

RCA SERVICE INCLUDES THESE IMPORTANT FEATURES:

- Complete inside proof of performance measurements and preparation of data.
- Complete checkup of antenna and transmission line system.
- Instruction on latest engineering and adjustment techniques for your equipment.
- Complete checks of transmitted signal quality with preventive maintenance recommendations.

Find out how RCA Contract Service minimizes equipment breakdowns. Call WOODLAWN 3-8000, Ext. PG-327, or contact your nearest broadcast representative.



RCA Service Company, Inc.
A Radio Corporation of America Subsidiary
Camden 2, New Jersey

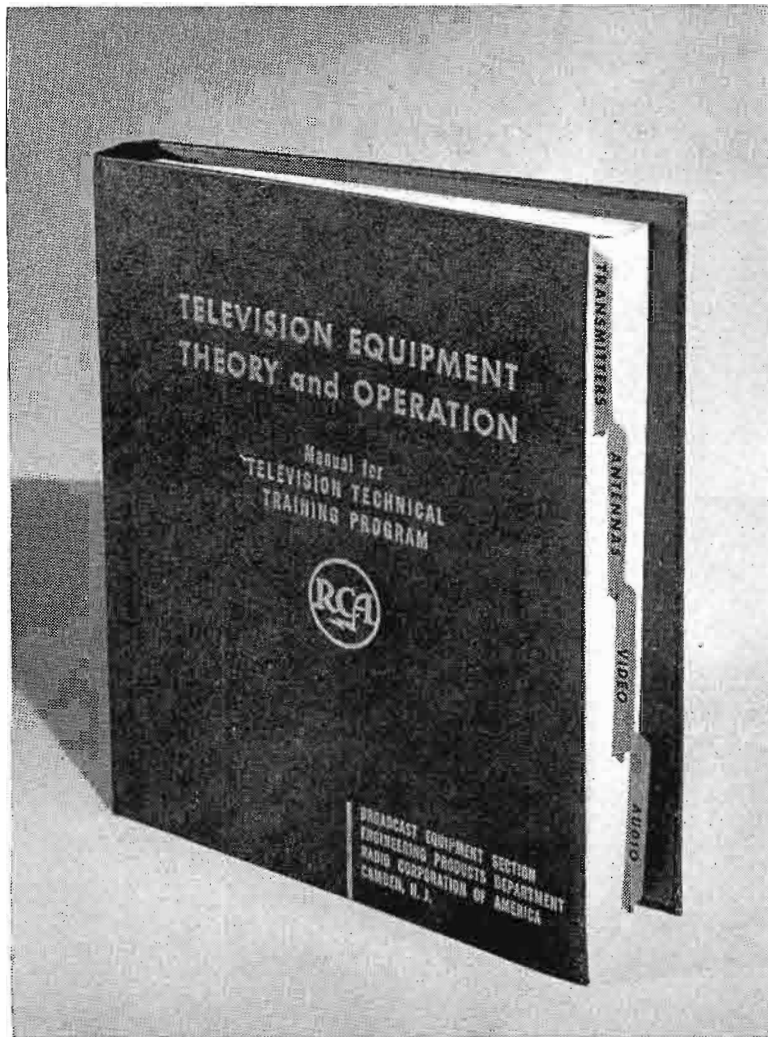

LATEST EDITION!

540 PAGES OF TV TECHNICAL DATA

AUTHORITATIVE . . . COMPLETE

An *up-to-date* reference for the television station engineer or planner. Provides complete coverage on Monochrome Television—its operation and maintenance. Contains complete descriptions, schematics, floor layouts, and illustrations that add clarity to the topics covered. Extensive, new material on UHF!

Used as a basis for successful RCA Television Broadcast training sessions, this reference has

earned the approval and acceptance of many Broadcasters.

It's a "must" for any TV library, and will enable you to effect appreciable savings by knowing how to properly plan, what equipment to buy and how to get the most out of your equipment.

NOW AVAILABLE AT \$10.00 EACH
Send orders with payment direct to E. T. Griffith, RCA Engineering Products Commercial Service, Building 15-7, Camden, New Jersey. Your RCA Training Manual will be promptly mailed to you.

Typical of the wealth of engineering information on television which the RCA Manual contains, is the spread illustrated here. Floor plans, schematics, circuit diagrams, and theoretical illustrations are included.

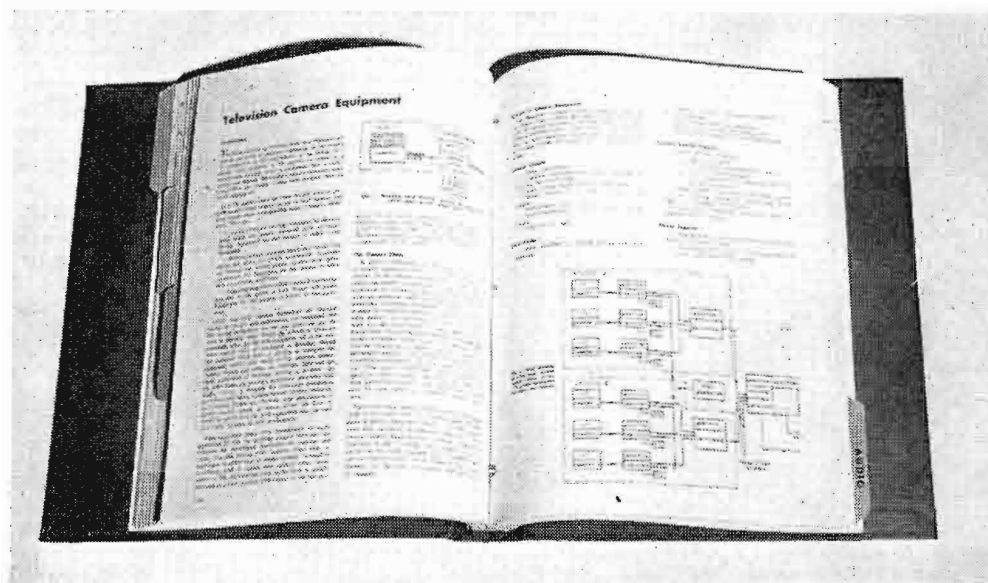

New Pressure Microphone

TV style!



BK-1A
All-New
Pressure Microphone
AM, FM and TV

THIS IS THE NEW MICROPHONE that made broadcast and television history at the political conventions. It includes every outstanding characteristic of the RCA 88-A, which it replaces, plus new advantages found in no other microphone in its price range or class. Check the facts!

- Type BK-1A is unobtrusive, even in the "close-ups." New styling, non-reflecting finish blends right into the TV picture
- Type BK-1A is absolutely insensitive to air blast and vibration—ideal for "close-ups"
- Type BK-1A has a frequency characteristic that is independent of distance from the sound source
- Type BK-1A has uniform response over the essential audio range
- Type BK-1A can be used in any kind of weather
- Type BK-1A detaches from base for hand-announcing (it can also be mounted on floor stands)
- Type BK-1A is equipped with a ball-and-swivel mount—can be turned in any direction
- Type BK-1A is only 8 inches high; weighs just 19 oz. (less base and cable)

For details and delivery information on this new remarkable semi-directional microphone, call your RCA Broadcast Sales Representative

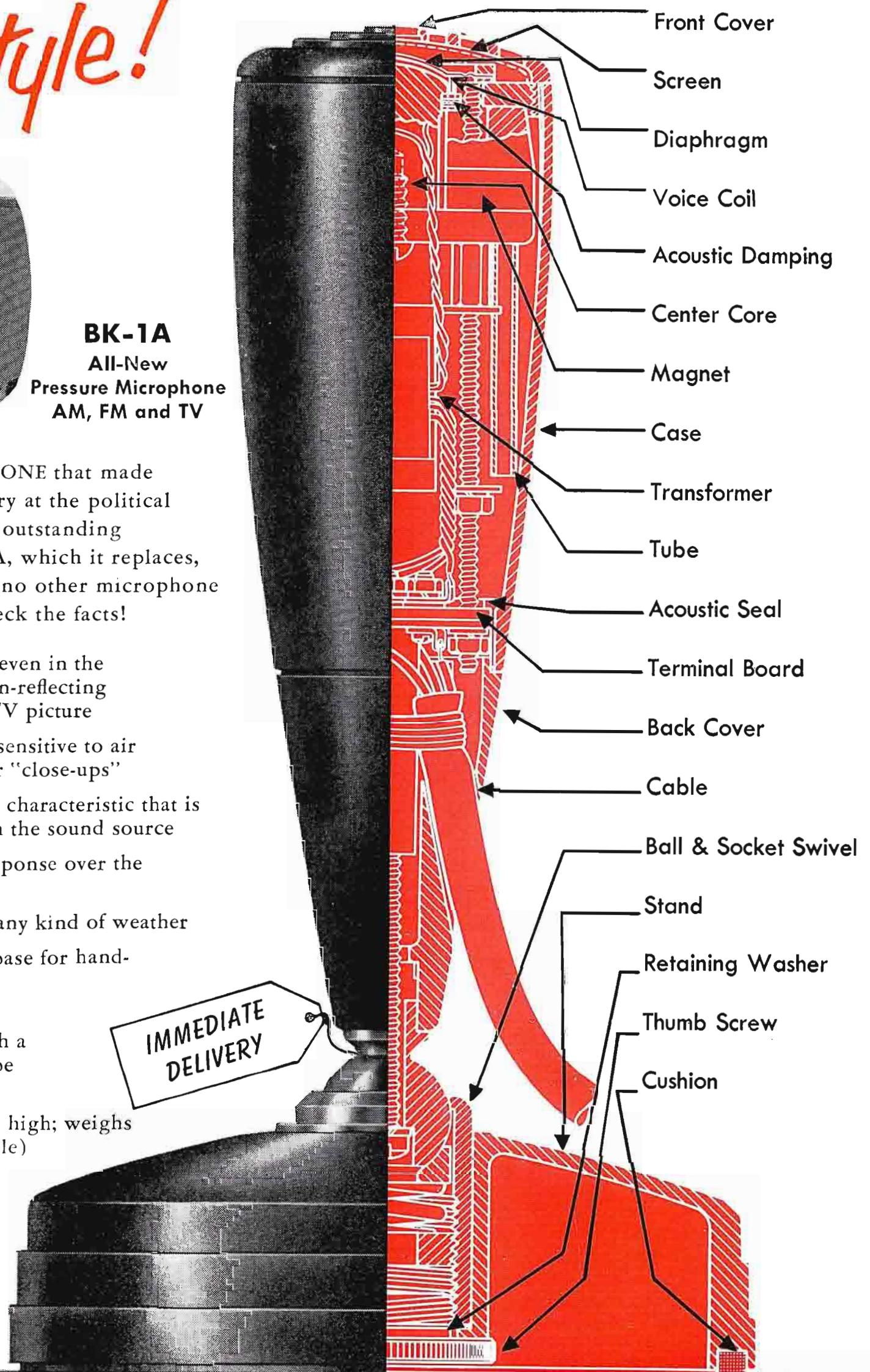

RADIO CORPORATION of AMERICA
ENGINEERING PRODUCTS DEPARTMENT
CAMDEN, N.J.

225 to 275 kW ERP!

With the RCA 25-kw VHF transmitter illustrated on the left—and the RCA 12-section VHF antenna on the right—VHF stations are reporting remarkable plant operating economy and spectacular coverage on channels 7 through 13. Here's why:

RCA's TT-25BH VHF transmitter

is designed with the lowest priced power amplifier tubes of any high-power VHF equipment in the business (aural and visual P.A.'s employ the "proved-in" RCA-5762; suggested price, only \$195 each). The entire equipment transmitter operates entirely air-cooled. (No water pumps, water interlocks, tanks, or plumbing are needed.) "Rollback" doors eliminate door-swing space (you save money on reduced floor area). Equipment cubicles are small enough to move through standard doorways, and in and out of standard elevators (you save on installation).

RCA's TF-12AH, 12-section antenna

enables you to virtually eliminate first null with practically no loss of gain. The antenna provides effective close-in coverage and vertical field-pattern shaping for constant field. Adjustable beam tilting (optional) insures best possible coverage and maximum reinforcement of your vertical pattern.

For complete information on how to get best possible coverage on channels 7 through 13—ECONOMICALLY—talk to your RCA Broadcast Sales Representative about this remarkable transmitter-antenna package. In Canada, write RCA Victor Ltd., Montreal.

This TF-12AH Superturnstile Antenna is radiating 251 kW ERP for KTEN-TV on channel 10.

Now ON-AIR at KTEN-TV

RCA's 25-kw VHF transmitter and 12-section antenna combination is delivering 251 kW ERP of visual power for KTEN-TV, channel 10—with spectacular coverage (at a level of 760 feet above terrain).



RADIO CORPORATION of AMERICA
ENGINEERING PRODUCTS DIVISION
CAMDEN, N.J.

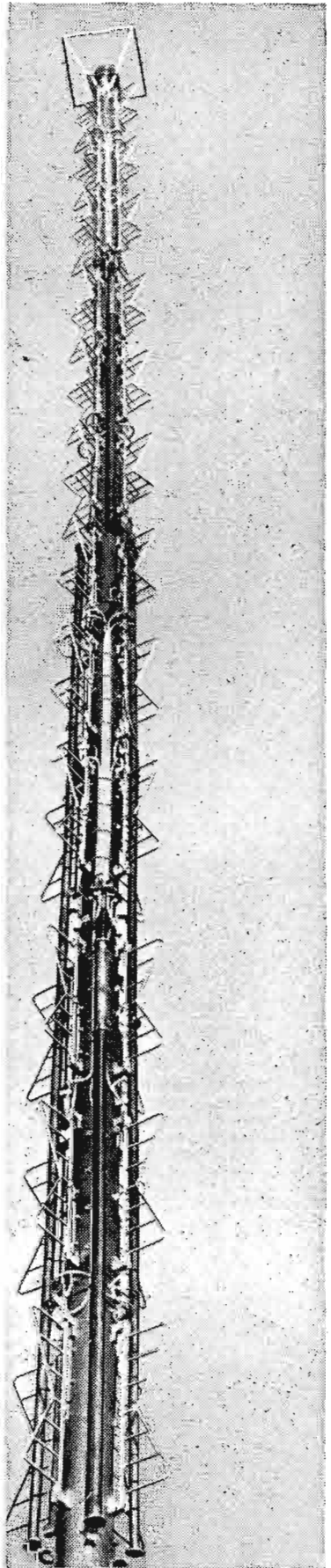

RCA

MICROWAVE

Industry's foremost TV Relay System

RCA Microwave Relay systems have been "proved-in-use" in both studio-transmitter circuits and field pick-up service. Today, RCA is the choice of television networks, telephone companies, and big TV stations—both in portable and fixed installations.

Your choice of Vertical or Horizontal Polarization. RCA microwave equipment can be arranged so that two links can be operated in the same channel. A choice of horizontal or vertical radiators (using RCA antenna waveguide feeds) eliminates inter-channel interference between individual links.

New TTR-1C/TTR-1D Microwave Relay Equipment. RCA's wide-band relay transmitter, receiver, and antenna units are designed for operation in accordance with FCC Color Standards. In short, *your equipment investment is protected!*

Simplified Design—Fewer Tubes. Tubes and circuits have been kept to a minimum. Only 5 tubes in the transmitter unit; only 6 in the receiver unit—including *klystrons!* All other tubes are at the control position (easily accessible).

"Built-in" Variable Wavemeter—High-Gain Antenna.

RCA's simplified design offers other benefits, too. For example, oscillator output is coupled with a waveguide and detector-monitor system so that it serves as a variable wavemeter. The RCA Parabolic Antenna provides gains up to 11,500. Frequency range is 6500-7125 mc.

Easy Accessibility and Convenient Rear Loading.

Transmitter and receiver chassis slide out easily from the weatherproof housing for quick maintenance. A keyhole-shaped cutout in the reflector enables you to insert the complete antenna/chassis assembly from the rear of the reflector.

Everything for Microwave. RCA's wide line of microwave equipment provides complete systems flexibility to meet specific needs. RCA not only has microwave transmitters, receivers, power supplies, antennas, parabolic reflectors. *RCA supplies every accessory required to put a TV relay system in operation.*

RCA engineers know TV microwave techniques from A to Z. For planning help and technical information, call your RCA Broadcast Sales Representative. In Canada, write RCA-Victor Ltd., Montreal.

FREE, 8- and 12-page illustrated brochures on the RCA TV Microwave System and RCA Microwave accessories. The books include complete data, plans, accessories, physical dimensions. Get a free copy from your RCA Broadcast Sales Representative.

RCA PIONEERED AND DEVELOPED COMPATIBLE COLOR TELEVISION



RADIO CORPORATION of AMERICA
ENGINEERING PRODUCTS DIVISION
CAMDEN, N. J.

NEW

BROADCAST

AUDIO

EQUIPMENT

for

AM • FM • TELEVISION

MICROPHONES

CONSOLES

CUSTOM EQUIPMENT

AMPLIFIERS

RACK EQUIPMENT

TURNTABLES

RECORDERS

SPEAKERS

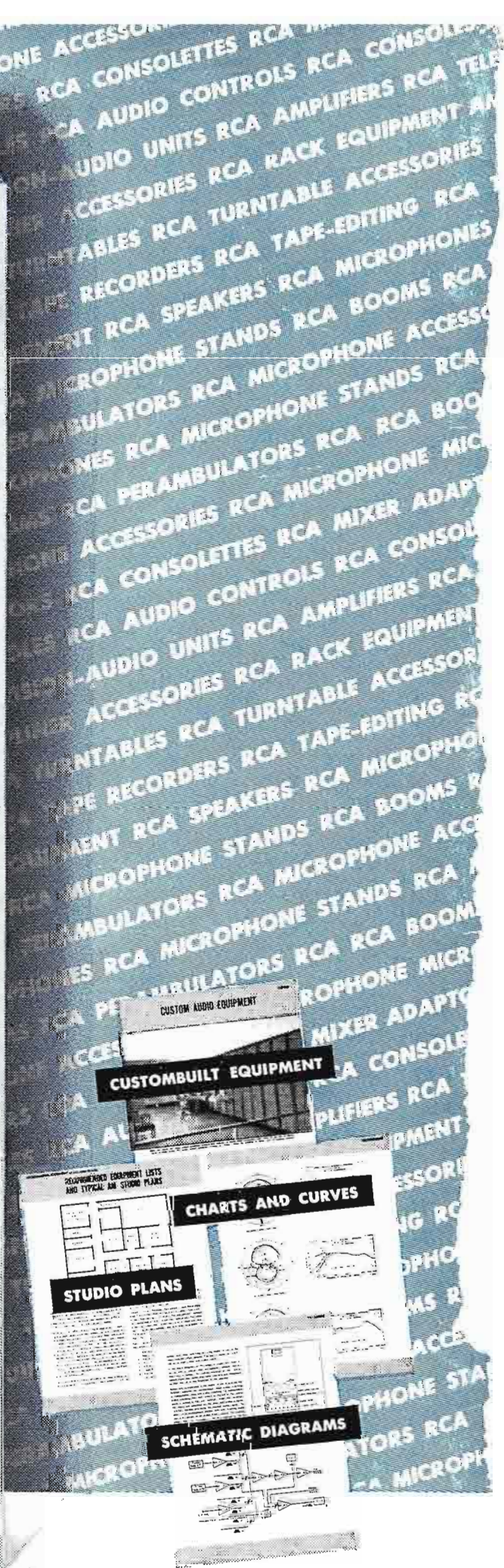

AUDIO catalog for Broadcasters

AM

FM

TV

THIS 146-PAGE CATALOG contains "straight-to-the-point" information about all RCA audio equipment and accessories designed for broadcast and television station operations. The book covers more than 200 professional audio items . . . and includes data, specifications, response curves, typical station equipment lists,

and studio layouts. It's authoritative. It's complete. It's the only book of its kind in the industry.

For your copy of the RCA Audio Catalog, ask your RCA Broadcast Sales Representative. Or write Dept. XX, RCA Engineering Products, Camden, N. J., on your station letterhead. In Canada, write RCA Victor Ltd., Montreal.



RADIO CORPORATION of AMERICA
ENGINEERING PRODUCTS DIVISION
CAMDEN, N.J.